

INTRODUCTION



Read this manual carefully and become familiar with your pressure washer. Know its applications, its limitations and any hazards involved.

Thank You for Purchasing a John Deere Product

We appreciate having you as a customer and wish you many years of safe and satisfied use of your machine.

Using Your Operator's Manual

This manual is an important part of your machine and should remain with the machine when you sell it.

Reading your operator's manual will help you and others avoid personal injury or damage to the machine. Information given in this manual will provide the operator with the safest and most effective use of the machine. Knowing how to operate this machine safely and correctly will allow you to train others who may operate this machine.

This manual contains information for a pressure washer that operates at 3,000 PSI at a flow rate of 2.8 gallons per minute. This professional quality residential system features 10" wheels, triplex pump with stainless steel pistons, automatic cool down system, detergent siphoning system, variety of spray tips, safety goggles, heavy duty 35' hose, and more.

This manual and safety signs on your machine may also be available in other languages (see your authorized dealer to order).

Sections in your operator's manual are placed in a specific order to help you understand all the safety messages and learn the controls so you can operate this machine safely. You can also use this manual to answer any specific operating or servicing questions.

Special Messages

Your manual contains special messages to bring attention to potential safety concerns, machine damage as well as helpful operating and servicing information. Please read all the information carefully to avoid injury and machine damage.

This product is rated in accordance with PWMA standard PW101 (www.pwma.org). Actual pressure at the point of discharge may vary due to factors including: the inclusion or exclusion of a detergent injection system; variations in engine performance; and environmental conditions.



WARNING

The engine exhaust from this product contains chemicals known to the State of California to cause cancer, birth defects, or other reproductive harm.

PRODUCT IDENTIFICATION

Record Identification Numbers

Pressure Washer

If you need to contact an Authorized Dealer for information on servicing, always provide the product model and identification numbers.

You will need to locate the model, revision and serial number for the machine and record the information in the places provided below. You will also need the model and serial number for the engine on your machine. See the engine operators manual for the location of these numbers.

DATE OF PURCHASE:

DEALER NAME:

DEALER PHONE:



PRODUCT IDENTIFICATION NUMBERS

MODEL (A):

REVISION:

SERIAL NUMBER

ENGINE

MODEL:

SERIAL NUMBER:

TABLE OF CONTENTS

SAFETY	1
Safety Rules	2
ASSEMBLY	5
Unpack Pressure Washer	5
Attach Handle	5
OPERATING	6
Daily Operating Checklist	7
Add Engine Oil and Fuel	7
Connect Hose and Water Supply to Pump	7
Pressure Washer Location	8
How to Start Your Pressure Washer	8
How to Stop Your Pressure Washer	9
How to Use Spray Tips	10
Cleaning and Applying Detergent	10
How to Rinse After Use	11
Cleaning Detergent Siphoning Tube	11
Automatic Cool Down System (Thermal Relief)	11
After Each Use	12
REPLACEMENT PARTS	13
Service Literature	13
SPECIFICATIONS	13
SERVICE PRESSURE WASHER	14
Pressure Washer Maintenance	14
Pump Oil Maintenance	15
Engine Maintenance	15
TROUBLESHOOTING	16
STORAGE	17
Winter Storage	17
Long Term Storage	17
WARRANTY	18
GETTING QUALITY SERVICE	19
SERVICE RECORD	20

John Deere® and the leaping deer logo are registered trademarks of Deere & Co. and are used under license to Briggs & Stratton Power Products.

All information, illustrations and specifications in this manual are based on the latest information at the time of publication. The right is reserved to make changes at any time without notice and without incurring obligation.

Copyright © 2007 Briggs & Stratton
Power Products Group, LLC.
All rights reserved.

No part of this material may be reproduced or transmitted in any form by any means without the express written permission of
Briggs & Stratton Power Products Group, LLC.

OMM156510

SAFETY

Understanding The Machine Safety Labels

The machine safety label shown below is placed on your machine to draw attention to potential safety hazards.

WARNING



Failure to read and follow instructions in manual(s) could result in death, bodily injury, and/or property damage.



Running engines give off carbon monoxide, an odorless, colorless, poison gas. DO NOT run in enclosed area, even if windows and doors are open.



Fuel and its vapors are flammable and explosive. Turn engine off and let it cool at least 2 minutes before refueling.



Risk of explosion. DO NOT spray flammable liquids.



Hot parts and exhaust gases can exceed 150° F and cause burns. DO NOT touch hot parts and AVOID hot exhaust gases.



ALWAYS point gun in safe direction and squeeze spray gun trigger, to release pressure and avoid kickback each time, before starting engine. Rapid retraction of starter cord (kickback) will pull hand and arm toward engine faster than you can let go. Injury could result.

Gun kicks back - Hold with both hands.



Risk of fluid injection. Never spray people or animals, as injury could result. Spray gun traps high water pressure, even when engine is stopped and water is disconnected. ALWAYS point gun in safe direction and squeeze spray gun trigger, to release high pressure, every time you stop engine. Engage trigger lock when not in use.



Risk of eye injury. Spray can propel objects. Always wear safety goggles.



Risk of electrocution. Never spray near power source.

See reverse side for operating instructions.



SAFETY

SAVE THESE INSTRUCTIONS

Safety Rules

 This is the safety alert symbol. It is used to alert you to potential personal injury hazards. Obey all safety messages that follow this symbol to avoid possible injury or death.

The safety alert symbol () is used with a signal word (DANGER, CAUTION, WARNING), a pictorial and/or a safety message to alert you to hazards. **DANGER** indicates a hazard which, if not avoided, *will* result in death or serious injury. **WARNING** indicates a hazard which, if not avoided, *could* result in death or serious injury. **CAUTION** indicates a hazard which, if not avoided, *might* result in minor or moderate injury. **NOTICE** indicates a situation that could result in equipment damage. Follow safety messages to avoid or reduce the risk of injury or death.

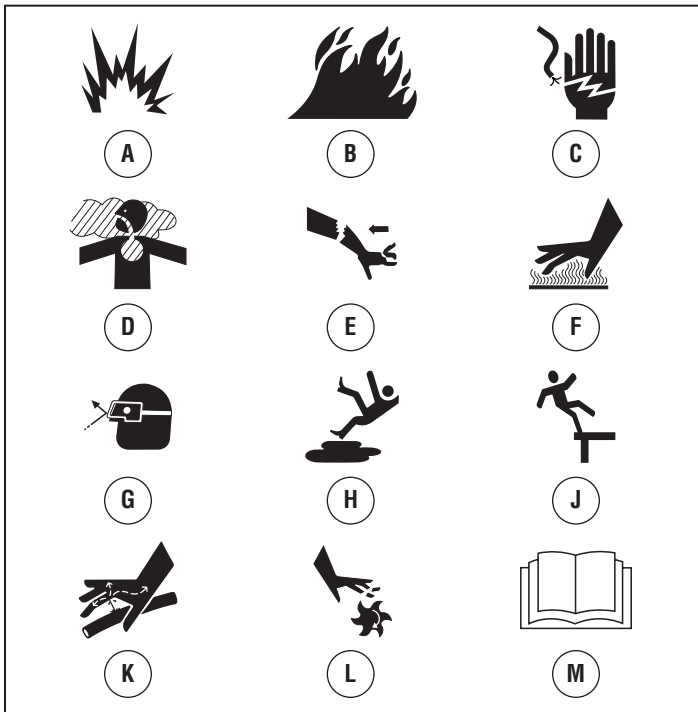

Hazard Symbols and Meanings





- A - Explosion
- B - Fire
- C - Electric Shock
- D - Toxic Fumes
- E - Kickback
- F - Hot Surface



- G - Flying Objects
- H - Slippery Surface
- J - Fall
- K - Fluid Injection
- L - Moving Parts
- M - Read Manual



 WARNING	
<p>The engine exhaust from this product contains chemicals known to the State of California to cause cancer, birth defects, or other reproductive harm.</p>	



 WARNING	
	<p>Running engine gives off carbon monoxide, an odorless, colorless, poison gas.</p> <p>Breathing carbon monoxide can cause headache, fatigue, dizziness, vomiting, confusion, seizures, nausea, fainting or death.</p> <p>Some chemicals or detergents may be harmful if inhaled or ingested, causing severe nausea, fainting, or poisoning.</p>
<ul style="list-style-type: none"> • Operate pressure washer ONLY outdoors. • Keep exhaust gas from entering a confined area through windows, doors, ventilation intakes, or other openings. • DO NOT start or run engine indoors or in an enclosed area, even if windows and doors are open. • Use a respirator or mask whenever there is a chance that vapors may be inhaled. • Read all instructions with mask so you are certain the mask will provide the necessary protection against inhaling harmful vapors. 	



 WARNING	
	<p>Use of pressure washer can create puddles and slippery surfaces.</p> <p>Kickback from spray gun can cause you to fall.</p>
<ul style="list-style-type: none"> • Operate pressure washer from a stable surface. • The cleaning area should have adequate slopes and drainage to reduce the possibility of a fall due to slippery surfaces. • Be extremely careful if you must use the pressure washer from a ladder, scaffolding, or any other similar location. • Firmly grasp spray gun with both hands when using high pressure spray to avoid injury when spray gun kicks back. 	



SAFETY

 WARNING	
	Fuel and its vapors are extremely flammable and explosive.
	Fire or explosion can cause severe burns or death.
WHEN ADDING OR DRAINING FUEL	
<ul style="list-style-type: none"> • Turn pressure washer OFF and let it cool at least 2 minutes before removing fuel cap. Loosen cap slowly to relieve pressure in tank. • Fill or drain fuel tank outdoors. • DO NOT overfill tank. Allow space for fuel expansion. • If fuel spills, wait until it evaporates before starting engine. • Keep fuel away from sparks, open flames, pilot lights, heat, and other ignition sources. • DO NOT light a cigarette or smoke. 	
WHEN STARTING EQUIPMENT	
<ul style="list-style-type: none"> • Ensure spark plug, muffler, fuel cap, and air cleaner are in place. • DO NOT crank engine with spark plug removed. 	
WHEN OPERATING EQUIPMENT	
<ul style="list-style-type: none"> • DO NOT tip engine or equipment at angle which causes fuel to spill. • DO NOT spray flammable liquids. 	
WHEN TRANSPORTING OR REPAIRING EQUIPMENT	
<ul style="list-style-type: none"> • Transport/repair with fuel tank EMPTY or with fuel shutoff valve OFF. • Disconnect spark plug wire. 	
WHEN STORING FUEL OR EQUIPMENT WITH FUEL IN TANK	
<ul style="list-style-type: none"> • Store away from furnaces, stoves, water heaters, clothes dryers, or other appliances that have pilot light or other ignition source because they can ignite fuel vapors. 	

 WARNING	
	Risk of electrocution. Contact with power source can cause electric shock or burn.
<ul style="list-style-type: none"> • NEVER spray near power source. 	

 WARNING	
	Starter cord kickback (rapid retraction) can result in bodily injury. Kickback will pull hand and arm toward engine faster than you can let go. Broken bones, fractures, bruises, or sprains could result.
<ul style="list-style-type: none"> • NEVER pull starter cord without first relieving spray gun pressure. • When starting engine, pull cord slowly until resistance is felt and then pull rapidly to avoid kickback. • After each starting attempt, where engine fails to run, always point spray gun in safe direction and squeeze spray gun trigger to release high pressure. • Firmly grasp spray gun with both hands when using high pressure spray to avoid injury when spray gun kicks back. 	

 WARNING	
	Contact with muffler area can result in serious burns.
	Exhaust heat/gases can ignite combustibles, structures or damage fuel tank causing a fire.
<ul style="list-style-type: none"> • DO NOT touch hot parts and AVOID hot exhaust gases. • Allow equipment to cool before touching. • Keep at least 5 feet (1.5 m) of clearance on all sides of pressure washer including overhead. • Code of Federal Regulation (CFR) Title 36 Parks, Forests, and Public Property require equipment powered by an internal combustion engine to have a spark arrester, maintained in effective working order, complying to USDA Forest service standard 5100-1C or later revision. In the State of California a spark arrester is required under section 4442 of the California Public resources code. Other states may have similar laws. 	

 WARNING	
	Unintentional sparking can result in fire or electric shock.
	
WHEN ADJUSTING OR MAKING REPAIRS TO YOUR PRESSURE WASHER	
<ul style="list-style-type: none"> • Disconnect the spark plug wire from the spark plug and place the wire where it cannot contact spark plug. 	
WHEN TESTING FOR ENGINE SPARK	
<ul style="list-style-type: none"> • Use approved spark plug tester. • DO NOT check for spark with spark plug removed. 	

SAFETY

WARNING



The high pressure stream of water that this equipment produces can cut through skin and its underlying tissues, leading to serious injury and possible amputation.

Spray gun traps high water pressure, even when engine is stopped and water is disconnected, which can cause injury.

- DO NOT allow CHILDREN to operate pressure washer.
- NEVER repair high pressure hose. Replace it.
- NEVER repair leaking connections with sealant of any kind. Replace o-ring or seal.
- NEVER connect high pressure hose to nozzle extension.
- Keep high pressure hose connected to pump and spray gun while system is pressurized.
- ALWAYS point spray gun in safe direction and squeeze spray gun trigger, to release high pressure, every time you stop engine.
- NEVER aim spray gun at people, animals, or plants.
- DO NOT secure spray gun in open position.
- DO NOT leave spray gun unattended while machine is running.
- NEVER use a spray gun which does not have a trigger lock or trigger guard in place and in working order.
- Always be certain spray gun, nozzles and accessories are correctly attached.

WARNING



Starter and other rotating parts can entangle hands, hair, clothing, or accessories.

- NEVER operate pressure washer without protective housing or covers.
- DO NOT wear loose clothing, jewelry or anything that may be caught in the starter or other rotating parts.
- Tie up long hair and remove jewelry.

WARNING



Risk of eye injury.

Spray can splash back or propel objects.

- Always wear safety goggles when using this equipment or in vicinity of where equipment is in use.
- Before starting the pressure washer, be sure you are wearing adequate safety goggles.
- NEVER substitute safety glasses for safety goggles.

NOTICE

High pressure spray may damage fragile items including glass.

- DO NOT point spray gun at glass when using red 0° spray tip.
- NEVER aim spray gun at plants.

NOTICE

Improper treatment of pressure washer can damage it and shorten its life.

- If you have questions about intended use, ask dealer or contact nearest authorized dealer.
- NEVER operate units with broken or missing parts, or without protective housing or covers.
- DO NOT by-pass any safety device on this machine.
- DO NOT tamper with governed speed.
- DO NOT operate pressure washer above rated pressure.
- DO NOT modify pressure washer in any way.
- Before starting pressure washer in cold weather, check all parts of the equipment to be sure ice has not formed there.
- NEVER move machine by pulling on hoses. Use handle provided on unit.
- Check fuel system for leaks or signs of deterioration, such as chafed or spongy hose, loose or missing clamps, or damaged tank or cap. Correct all defects before operating pressure washer.
- This equipment is designed to be used with Briggs & Stratton Power Products authorized parts **ONLY**. If equipment is used with parts that DO NOT comply with minimum specifications, user assumes all risks and liabilities.

ASSEMBLY

Your pressure washer requires some assembly and is ready for use after it has been properly serviced with the recommended oil and fuel.

If you have any problems with the assembly of your pressure washer, please call the pressure washer helpline at **(888) 228-3068**. If calling for assistance, please have the model, revision, and serial number from the data tag available.

Unpack Pressure Washer

1. Remove the parts bag, accessories, and inserts included with pressure washer.
2. Open carton completely by cutting each corner from top to bottom.
3. Ensure you have all included items prior to assembly.

Items in the carton include:

- Main Unit
- Handle
- High Pressure Hose
- Spray Gun
- Nozzle Extension with Quick Connect Fitting
- Oil Bottle
- Parts Bag (which includes the following):
 - Operator's Manual
 - Engine Operator's Manual
 - Owner's Registration Card
 - Safety Goggles
 - Bag containing 5 Multi-Colored Quick Connect Spray Tips
 - Handle Fastening Hardware Kit (which includes):
 - Carriage Bolts (2)
 - Plastic Knobs (2)

To prepare your pressure washer for operation, you will need to perform these tasks:

1. Fill out and send in registration card.
2. Verify oil dipstick (A) has been installed into pump.

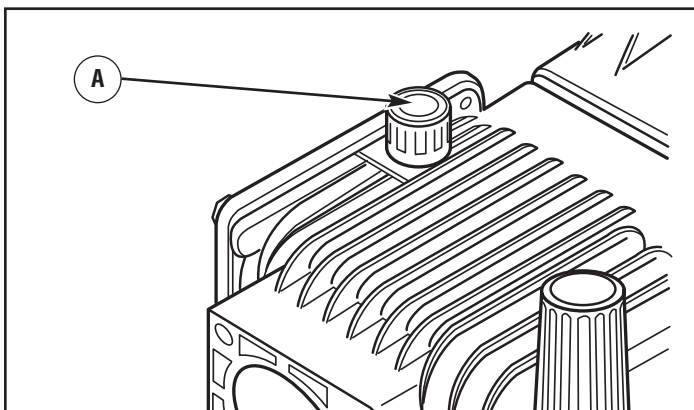

3. Attach handle to main unit.
4. Add oil to engine crankcase.
5. Add fuel to fuel tank.
6. Connect high pressure hose to spray gun and pump.
7. Connect water supply to pump.
8. Attach nozzle extension to spray gun.
9. Select/attach quick connect spray tip to nozzle extension.

Attach Handle

1. Place handle (A) onto handle supports (B) connected to main unit. Make sure holes (C) in handle align with holes on handle supports.

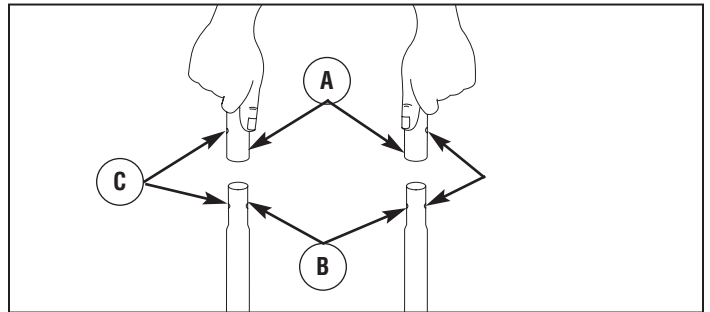

NOTE: It may be necessary to move the handle supports from side to side in order to align the handle so it will slide over the handle supports.

2. Insert carriage bolts through holes from outside of unit and attach a plastic knob from inside of unit. Tighten by hand.

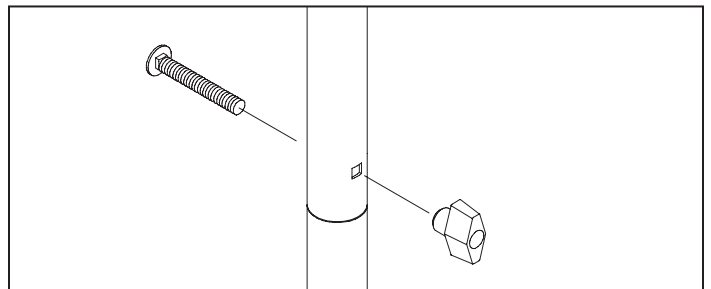

3. Insert multi-colored quick connect spray tips and other supplied accessories in spaces provided on handle.

OPERATING



Read this operator's manual and safety rules before operating your pressure washer.

Compare the illustration with your pressure washer to familiarize yourself with the locations of various controls and adjustments. Save this manual for future reference.

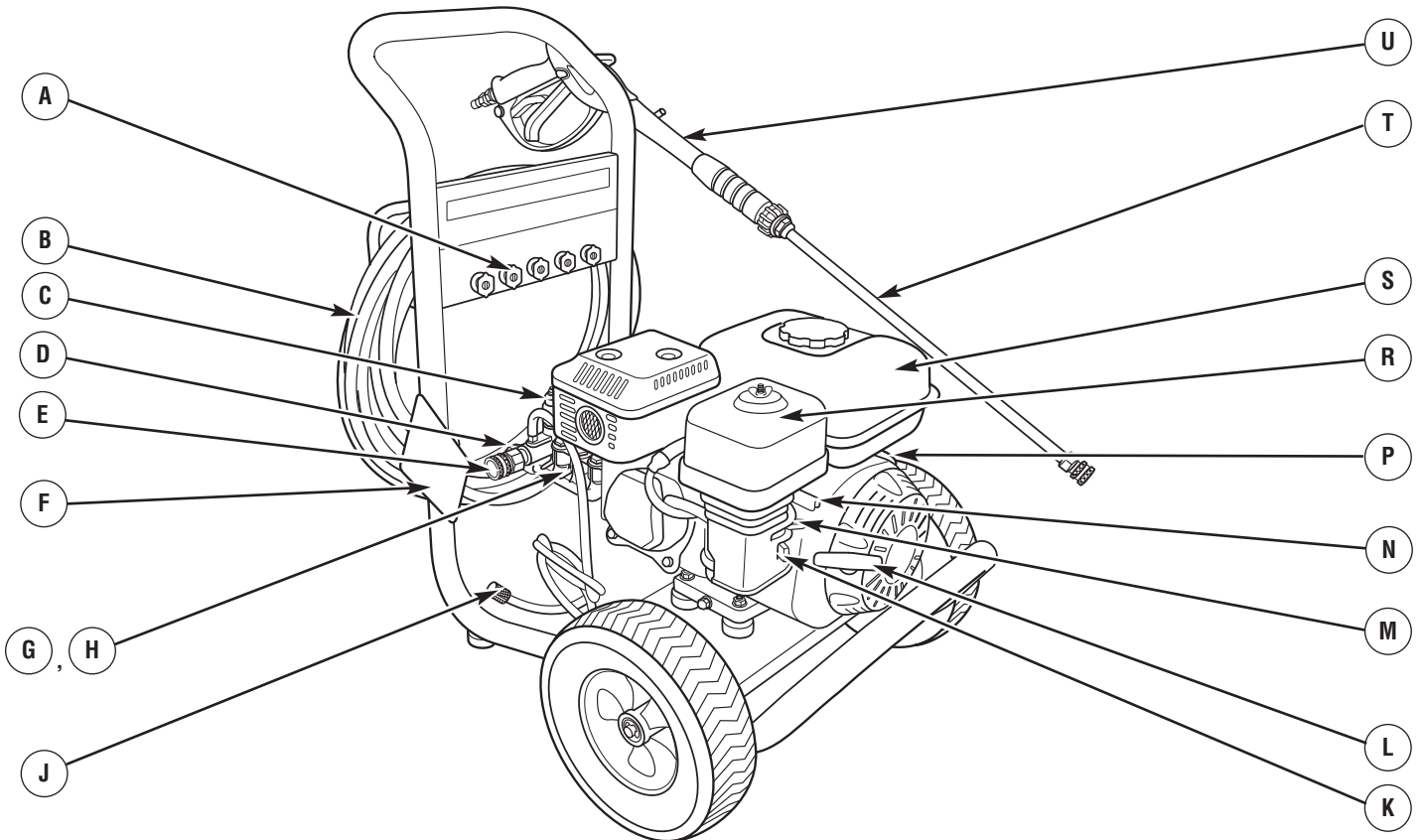

A - Spray Tips — Detergent, 0°, 15°, 25° and 40°: for various high pressure cleaning applications.

B - High Pressure Hose — Connect one end to water pump and the other end to spray gun.

C - Pressure Control Knob — Varies pressure of high pressure spray.

D - Water Inlet — Connection for garden hose.

E - High Pressure Outlet — Connection for high pressure hose.

F - Warning/Operating Instructions Tag — Identifies hazards and proper procedure to start/stop pressure washer.

G - Pump — Develops high pressure.

H - Automatic Cool Down System — Cycles water through pump when water reaches 125°-155°F. Warm water will discharge from pump onto ground. This system prevents internal pump damage.

J - Detergent Siphoning Tube/Filter — Use to siphon pressure washer safe detergent into the low pressure stream.

K - Choke Lever — Prepares a cold engine for starting.

L - Recoil Starter — Used for starting the engine manually.

M - Fuel Valve — Used to turn fuel supply on and off to engine.

N - Throttle Lever — Sets engine in starting mode for recoil starter.

P - Engine Switch — Set switch to "On" for recoil starting. Set switch to "Off" to stop a running engine.

R - Air Filter — Protects engine by filtering dust and debris out of intake air.

S - Fuel Tank — Fill tank with regular unleaded fuel. Always leave room for fuel expansion.

T - Nozzle Extension with Quick Connect — Allows you to switch between five different spray tips.

U - Spray Gun with Quick Connect — Controls the application of water onto cleaning surface with trigger device. Includes trigger lock.

Items Not Shown:

Data Tag (near rear of base plate) — Provides model and serial number of pressure washer. Please have these readily available if calling for assistance.

Oil Fill/Dipstick — Check and add oil here.

Safety Goggles — Always use the supplied safety goggles when running your pressure washer.

OPERATING

Daily Operating Checklist

Review the unit's assembly to ensure you have performed all of the following.

1. Make sure handle is in place and secure.
2. Check that oil has been added to proper level in the engine crankcase.
3. Add proper fuel to fuel tank.
4. Check for properly tightened hose connections.
5. Check to make sure there are no kinks, cuts, or damage to high pressure hose.
6. Provide a proper water supply at an adequate flow.
7. Be sure to read the *Safety* section before using pressure washer.

If you have any problems operating your pressure washer, please call the pressure washer helpline at **(888) 228-3068**.

Add Engine Oil and Fuel

- Place pressure washer on a level surface.

NOTE: Verify provided oil bottle is the correct viscosity for current ambient temperature.

NOTICE

Any attempt to crank or start the engine before it has been properly filled with the recommended oil will result in equipment failure.

- Refer to engine manual for oil and fuel fill information.
- Damage to equipment resulting from failure to follow this instruction will void warranty.
- Refer to engine operator's manual and follow oil and fuel recommendations and instructions.

NOTE: Check oil often during engine break-in. Refer to engine operator's manual for recommendations.

Connect Hose and Water Supply to Pump

NOTE: Remove and discard the shipping caps from the pump's high pressure outlet and water inlet before attaching hoses.

NOTICE

DO NOT run the pump without the water supply connected and turned on.

- Damage to equipment resulting from failure to follow this instruction will void warranty.

1. Uncoil high pressure hose and attach quick connect end of hose to base of spray gun. Pull down on collar of quick connect, slide onto spray gun and let go of collar. Tug on hose to be sure of tight connection.

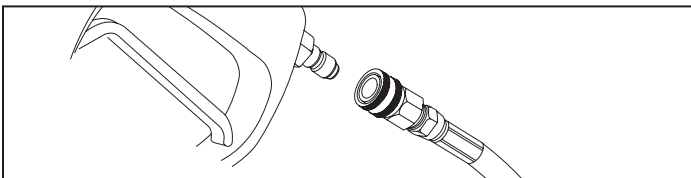

WARNING



The high pressure stream of water that this equipment produces can cut through skin and its underlying tissues, leading to serious injury and possible amputation.

- NEVER connect high pressure hose to nozzle extension.
- Keep high pressure hose connected to pump and spray gun while system is pressurized.
- Always be certain spray gun, nozzles and accessories are correctly attached.

2. Similarly, attach other end of high pressure hose to high pressure outlet (A) on pump. Pull down on collar of quick connect, slide onto pump and let go of collar. Pull on hose to be sure of tight connection.

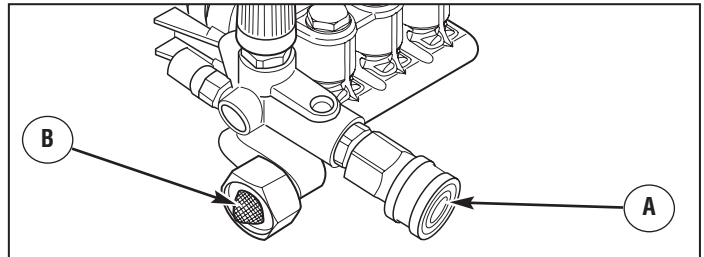

3. Before connecting garden hose to water inlet, inspect inlet screen (B). Clean screen if it contains debris or have it replaced if damaged. DO NOT run pressure washer if inlet screen is damaged.
4. Run water through your garden hose for 30 seconds to clean out any debris.

IMPORTANT: DO NOT siphon standing water for the water supply. Use ONLY cold water (less than 100°F).

5. Connect the garden hose (not to exceed 50 feet in length) to the water inlet. Tighten by hand.

NOTICE

Damage to pump or water inlet connector will occur if a One Way Valve (vacuum breaker or check valve) is connected to pump.

- There MUST be at least ten feet (3M) of unrestricted garden hose between the pressure washer inlet and any device, such as a One Way Valve.
- Damage to equipment caused by attaching a One Way Valve to pump will void warranty.

6. Turn ON the water, press red button on the gun and squeeze the trigger to purge the pump system of air and impurities.



WARNING



Risk of eye injury.



Spray can splash back or propel objects.

- Always wear safety goggles when using this equipment or in vicinity of where equipment is in use.
- Before starting the pressure washer, be sure you are wearing adequate safety goggles.
- NEVER substitute safety glasses for safety goggles.



OPERATING

Pressure Washer Location

Clearances and Air Movement

 WARNING	
	Exhaust heat/gases can ignite combustibles, structures or damage fuel tank causing a fire.
<ul style="list-style-type: none">• Keep at least 5 ft. (1.5 m) clearance on all sides of pressure washer including overhead.	

Place pressure washer in a well ventilated area, which will allow for removal of deadly exhaust gas. Do not place pressure washer where exhaust gas could accumulate and enter inside or be drawn into a potentially occupied building. Ensure exhaust gas (A) is kept away from any windows, doors, ventilation intakes, or other openings that can allow exhaust gas to collect in a confined area. Prevailing winds and air currents should be taken into consideration when positioning pressure washer.

 WARNING	
	Running engine gives off carbon monoxide, an odorless, colorless, poison gas. Breathing carbon monoxide can cause headache, fatigue, dizziness, vomiting, confusion, seizures, nausea, fainting or death.
<ul style="list-style-type: none">• Operate pressure washer ONLY outdoors.• Keep exhaust gas from entering a confined area through windows, doors, ventilation intakes, or other openings.• DO NOT start or run engine indoors or in an enclosed area, even if windows and doors are open.	

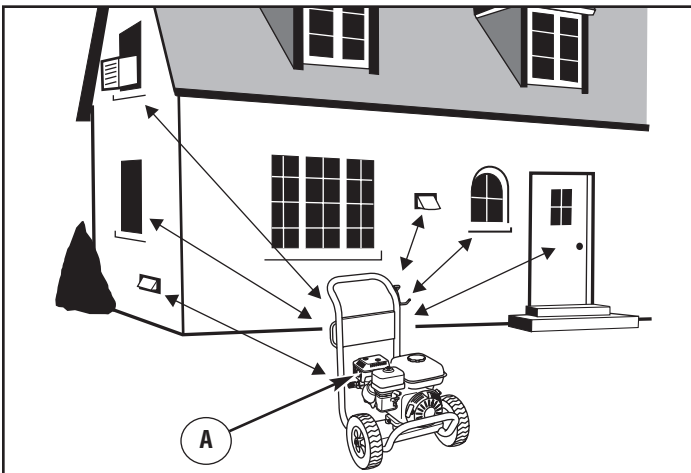

How to Start Your Pressure Washer

To start your pressure washer for the first time, follow these instructions step-by-step. This starting information also applies if you have let the pressure washer sit idle for at least a day.

1. Place pressure washer near an outside water source capable of supplying water at a flow rate greater than 3.8 gallons per minute and no less than 20 PSI at pressure washer end of garden hose. DO NOT siphon supply water.
2. Check that high pressure hose is tightly connected to spray gun and pump. See *Assembly* section.
3. Make sure unit is in a level position.
4. Connect garden hose to water inlet on pressure washer pump.

NOTICE	
DO NOT run the pump without the water supply connected and turned on.	
<ul style="list-style-type: none">• Damage to equipment resulting from failure to follow this instruction will void warranty.	

5. Turn ON water, point gun in a safe direction, press the red button and squeeze trigger to purge pump system of air and impurities.
6. Attach nozzle extension to spray gun. Tighten by hand.

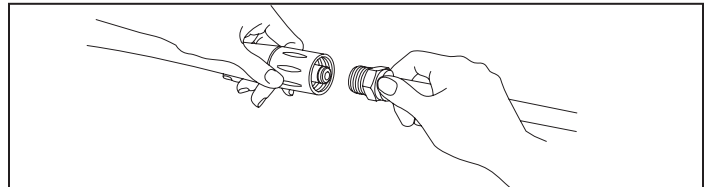

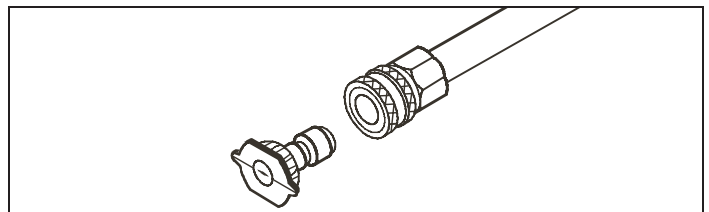

7. Choose desired spray tip, pull back nozzle extension collar, insert spray tip and release collar. Tug on spray tip to make sure it is securely in place. See *How to Use Spray Tips*.





OPERATING



IMPORTANT: Before starting the pressure washer, be sure you are wearing adequate safety goggles.

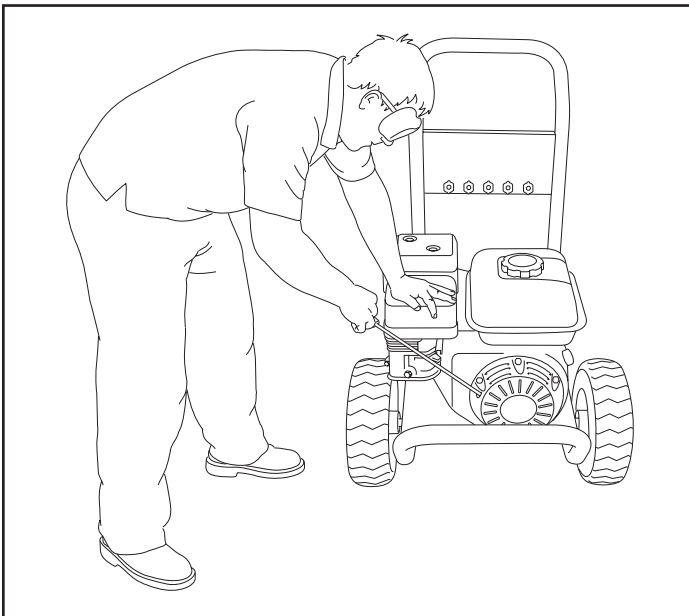

 WARNING	
	Risk of eye injury. Spray can splash back or propel objects.
<ul style="list-style-type: none"> • Always wear safety goggles when using this equipment or in vicinity of where equipment is in use. • Before starting the pressure washer, be sure you are wearing adequate safety goggles. • NEVER substitute safety glasses for safety goggles. 	

8. When starting engine, position yourself as recommended and start engine according to instructions given in engine operator's manual. Also see operating instructions tag located on the pressure washer.



 WARNING	
	Starter cord kickback (rapid retraction) can result in bodily injury. Kickback will pull hand and arm toward engine faster than you can let go. Broken bones, fractures, bruises, or sprains could result.
<ul style="list-style-type: none"> • NEVER pull starter cord without first relieving spray gun pressure. • When starting engine, pull cord slowly until resistance is felt and then pull rapidly to avoid kickback. • After each starting attempt, where engine fails to run, always point spray gun in safe direction, press red button and squeeze spray gun trigger to release high pressure. • Firmly grasp spray gun with both hands when using high pressure spray to avoid injury when spray gun kicks back. 	

 WARNING	
	The high pressure stream of water that this equipment produces can cut through skin and its underlying tissues, leading to serious injury and possible amputation. Spray gun traps high water pressure, even when engine is stopped and water is disconnected, which can cause injury.
<ul style="list-style-type: none"> • DO NOT allow CHILDREN to operate pressure washer. • Keep high pressure hose connected to pump and spray gun while system is pressurized. • NEVER aim spray gun at people, animals, or plants. • DO NOT secure spray gun in open position. • DO NOT leave spray gun unattended while machine is running. • NEVER use a spray gun which does not have a trigger lock or trigger guard in place and in working order. • Always be certain spray gun, nozzles and accessories are correctly attached. 	

 WARNING	
	Contact with muffler area can result in serious burns.
	Exhaust heat/gases can ignite combustibles, structures or damage fuel tank causing a fire.
<ul style="list-style-type: none"> • DO NOT touch hot parts and AVOID hot exhaust gases. • Allow equipment to cool before touching. • Keep at least 5 feet (1.5 m) of clearance on all sides of pressure washer including overhead. • Code of Federal Regulation (CFR) Title 36 Parks, Forests, and Public Property require equipment powered by an internal combustion engine to have a spark arrester, maintained in effective working order, complying to USDA Forest service standard 5100-1C or later revision. In the State of California a spark arrester is required under section 4442 of the California Public resources code. Other states may have similar laws. 	

How to Stop Your Pressure Washer

1. Release spray gun trigger and let engine idle for two minutes.
2. Turn engine off according to instructions given in engine operator's manual.
3. ALWAYS point spray gun in a safe direction, press red button and squeeze spray gun trigger to release retained high water pressure.

IMPORTANT: Spray gun traps high water pressure, even when engine is stopped and water is disconnected.

OPERATING

⚠ WARNING	
	The high pressure stream of water that this equipment produces can cut through skin and its underlying tissues, leading to serious injury and possible amputation.
	Spray gun traps high water pressure, even when engine is stopped and water is disconnected, which can cause injury.
<ul style="list-style-type: none"> • Keep high pressure hose connected to pump and spray gun while system is pressurized. • ALWAYS point spray gun in safe direction, press red button and squeeze spray gun trigger, to release high pressure, every time you stop engine. 	

IMPORTANT: Spray gun traps high water pressure, even when engine is stopped and water is disconnected.

How to Use Spray Tips

The quick-connect on the nozzle extension allows you to switch between five different quick connect spray tips. Spray tips can be changed while pressure washer is running once spray gun trigger safety lock is engaged. The spray tips vary the spray pattern as shown below.

⚠ WARNING	
	The high pressure stream of water that this equipment produces can cut through skin and its underlying tissues, leading to serious injury and possible amputation.
	<ul style="list-style-type: none"> • NEVER exchange spray tips without the trigger safety lock engaged on the spray gun. • DO NOT twist spray tips while spraying.

Follow these instructions to change spray tips:

1. Pull back collar on quick-connect and pull current spray tip off. Store spray tips in holder provided on the handle.
2. Select desired spray tip:
 - For gentle rinse, select white 40° or green 25° spray tip.
 - To scour surface, select yellow 15° or red 0° spray tip.
 - To apply detergent, select black spray tip.

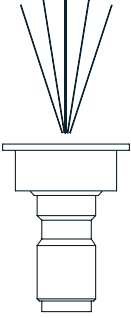
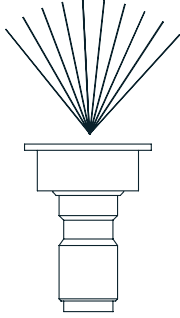
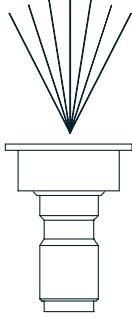
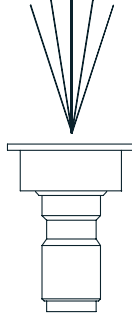
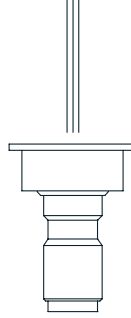
<p>Low Pressure Use to apply detergent</p>  <p>Black</p>	 <p>White 40°</p>	 <p>Green 25°</p>	 <p>Yellow 15°</p>	 <p>Red 0°</p> <p>High Pressure</p>
--	--	--	---	---

3. Pull back on collar, insert new spray tip and release collar. Tug on spray tip to make sure it is securely in place.

Usage Tips

- For most effective cleaning, keep spray tip from 8 to 24 inches away from cleaning surface.
- If you get spray tip too close, especially using a high pressure spray tip, you may damage surface being cleaned.
- DO NOT get closer than 6 inches when cleaning tires.

Cleaning and Applying Detergent

⚠ CAUTION	
Chemicals can cause bodily injury, and/or property damage.	
<ul style="list-style-type: none"> • NEVER use caustic liquid with pressure washer. • Use ONLY pressure washer safe detergents/soaps. Follow all manufacturers instructions. 	

To apply detergent, follow these steps:

1. Review use of spray tips.
2. Prepare detergent solution as required by job.
3. Place small filter end of detergent siphoning tube into detergent container.

NOTE: Make sure the filter is fully submerged in detergent while applying detergent.

NOTICE	
Contact with the hot muffler can damage detergent siphoning tube.	
<ul style="list-style-type: none"> • When inserting the filter into a detergent solution bottle, route the tube so as to keep it from inadvertently contacting the hot muffler. 	

4. Make sure black spray tip is installed.

NOTE: Detergent cannot be applied with the high pressure spray tips (White, Green, Yellow or Red).

OPERATING

5. Make sure garden hose is connected to water inlet. Check that high pressure hose is connected to spray gun and pump. Turn on water.

NOTICE

You must attach all hoses before you start the engine.

- Starting the engine without all the hoses connected and without the water turned ON will damage the pump.
- Damage to equipment resulting from failure to follow this instruction will void warranty.

6. Start engine following instructions *How to Start Your Pressure Washer*.
7. Apply detergent to a dry surface, starting at lower portion of area to be washed and work upward, using long, even, overlapping strokes.
8. Allow detergent to "soak in" for 3-5 minutes before washing and rinsing. Reapply as needed to prevent surface from drying. DO NOT allow detergent to dry on (prevents streaking).

IMPORTANT: You must flush the detergent siphoning system after each use by placing the filter into a bucket of clean water, then run the pressure washer in low pressure for 1-2 minutes.

How to Rinse After Use

Pressure Washer Rinsing

1. Remove black spray tip from nozzle extension.
2. Select and install desired high pressure spray tip following instructions *How to Use Spray Tips*.
3. Keep spray gun a safe distance from area you plan to spray.

WARNING



Kickback from spray gun can cause you to fall.

- Operate pressure washer from a stable surface.
- Be extremely careful if you must use the pressure washer from a ladder, scaffolding, or any other similar location.
- Firmly grasp spray gun with both hands when using high pressure spray to avoid injury when spray gun kicks back.

4. Increase (decrease) spray pressure by turning pressure control knob (A) clockwise (counterclockwise). Use lower pressure to wash items such as a car or boat. Use higher pressure to strip paint and degrease driveways.

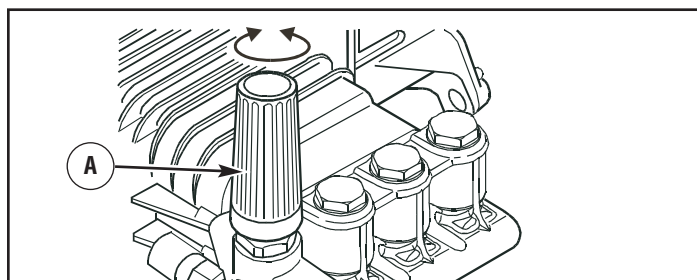

5. Apply a high pressure spray to a small area and then check surface for damage. If no damage is found, you can assume it is okay to continue rinsing.
6. Start at top of area to be rinsed, working down with same overlapping strokes as you used for cleaning.

Cleaning Detergent Siphoning Tube

If you used the detergent siphoning tube, you must flush it with clean water before stopping the engine.

1. Place detergent siphoning tube/filter in a bucket full of clean water.
2. Remove high pressure spray tip from nozzle extension.
3. Select and install black detergent spray tip following instructions *How to Use Spray Tips*.
4. Flush for 1-2 minutes.
5. Shut off engine following instructions *How to Stop Pressure Washer* and turn off water supply.
6. ALWAYS point spray gun in a safe direction, press red button and squeeze spray gun trigger to release retained high water pressure.

IMPORTANT: Spray gun traps high water pressure, even when engine is stopped and water is disconnected.

WARNING



The high pressure stream of water that this equipment produces can cut through skin and its underlying tissues, leading to serious injury and possible amputation.

Spray gun traps high water pressure, even when engine is stopped and water is disconnected, which can cause injury.

- Keep high pressure hose connected to pump and spray gun while system is pressurized.
- ALWAYS point spray gun in safe direction, press red button and squeeze spray gun trigger, to release high pressure, every time you stop engine.

Automatic Cool Down System (Thermal Relief)



If you run the engine on your pressure washer for 3-5 minutes without pressing the trigger on the spray gun, circulating water in the pump can reach temperatures above 125°F. The system engages to cool the pump by **discharging the warm water onto the ground.**

OPERATING



After Each Use

Water should not remain in the unit for long periods of time. Sediments or minerals can deposit on pump parts and freeze pump action. Follow these procedures after every use:

1. Flush detergent siphoning tube by placing the filter into a pail of clean water while running pressure washer in low pressure mode. Flush for one to two minutes.
2. Shut off engine, turn off water supply, point gun in a safe direction, press red button and squeeze trigger to relieve trapped pressure, and let engine cool.

 WARNING	
	<p>The high pressure stream of water that this equipment produces can cut through skin and its underlying tissues, leading to serious injury and possible amputation.</p> <p>Spray gun traps high water pressure, even when engine is stopped and water is disconnected, which can cause injury.</p>
<ul style="list-style-type: none">• Keep high pressure hose connected to pump and spray gun while system is pressurized.• ALWAYS point spray gun in safe direction, press red button and squeeze spray gun trigger, to release high pressure, every time you stop engine.	

3. Disconnect hose from spray gun and high pressure outlet on pump. Drain water from hose, gun, and nozzle extension. Use a rag to wipe off the hose.
4. Place the spray gun, nozzle extension, spray tips and high pressure hose on the handle.
5. Empty pump of all pumped liquids by pulling recoil handle about six times. This should remove most liquid in pump.
6. Store unit in a clean, dry area.
7. If storing for more than 30 days, see *Long Term Storage*.

 WARNING	
	Fuel and its vapors are extremely flammable and explosive.
	Fire or explosion can cause severe burns or death.
WHEN STORING FUEL OR EQUIPMENT WITH FUEL IN TANK	
<ul style="list-style-type: none">• Store away from furnaces, stoves, water heaters, clothes dryers, or other appliances that have pilot light or other ignition source because they can ignite fuel vapors.	

REPLACEMENT PARTS AND SPECIFICATIONS

Service Literature

If you would like a copy of the Parts Catalog or Technical Manual for this machine call **(888) 228-3068** or contact your local dealer.

Parts

We recommend John Deere quality parts and lubricants, available at your John Deere dealer.

Part numbers may change - use part numbers listed below when you order. If a number changes, your dealer will have the latest number.

When you order parts, your John Deere dealer needs your machine model and revision number. He may also need your engine Model and serial number. These are the numbers that you recorded in *Product Identification*.

Part Numbers

PumpSaver6039
Pump Oil6033
O-Ring Maintenance Kit6048
Water Inlet Screen	B2384GS
John Deere Turf Gard Engine Oil Bottle	Contact Dealer
Fuel Stabilizer5041D

(Part numbers are subject to change without notice. Part numbers may be different outside the U.S.A.)

Product Specifications

Model 3000

Outlet Pressure3000 PSI (206.8 BAR)
Flow Rate	2.8 GPM (10.6 liters/min)
Water Supply Temperature	Not to exceed 100°F (38°C)
Pump Oil Capacity9.6 fl. oz.
Shipping Weight	84 lbs. (38.1 kg)

This product is rated in accordance with PWMA standard PW101 (www.pwma.org). Actual pressure at the point of discharge may vary due to factors including: the inclusion or exclusion of a detergent injection system; variations in engine performance; and environmental conditions.

SERVICE PRESSURE WASHER

Maintenance

General Recommendations

Regular maintenance will improve the performance and extend the life of the pressure washer. See any qualified dealer for service.

The pressure washer's warranty does not cover items that have been subjected to operator abuse or negligence. To receive full value from the warranty, the operator must maintain the pressure washer as instructed in this manual and in the engine manual, including proper storage as detailed in *Winter Storage* and *Long Term Storage*.

NOTE: Should you have questions about replacing components on your pressure washer, please call **(888) 228-3068** for assistance.

- Some adjustments will need to be made periodically to properly maintain your pressure washer. Check the spray gun and nozzle extension assembly for wear.
- All maintenance in this manual and the engine operator's manual should be made at least once each season.
- Once a year you should clean or replace the spark plug, clean or replace the air filter. A new spark plug and clean air filter assure proper fuel-air mixture and help your engine run better and last longer. Please refer to your engine operator's manual for more details.

Pressure Washer Maintenance

Clean Debris

Daily or before use, clean accumulated debris from cleaning system. Keep linkage, spring and controls clean. Keep area around and behind muffler free from any combustible debris. Inspect cooling air slots and openings on the pressure washer. These openings must be kept clean and unobstructed.

Cleaning system parts should be kept clean to reduce the risk of overheating and ignition of accumulated debris.

NOTICE

Improper treatment of pressure washer can damage it and shorten its life.

- DO NOT insert any objects through cooling slots.

- Use a damp cloth to wipe exterior surfaces clean.
- Use a soft bristle brush to loosen caked on dirt, oil, etc.
- Use a vacuum cleaner to pick up loose dirt and debris.

Check and Clean Inlet Screen

Examine the screen on the pump's water inlet. Clean it if the screen is clogged or replace it if screen is damaged.

Check High Pressure Hose

The high pressure hose can develop leaks from wear, kinking, or abuse. Inspect the hose each time before using it. Check for cuts, leaks, abrasions or bulging of cover, damage or movement of couplings. If any of these conditions exist, replace the hose immediately.



WARNING



The high pressure stream of water that this equipment produces can cut through skin and its underlying tissues, leading to serious injury and possible amputation.

- NEVER repair high pressure hose. Replace it.
- Replacement hose rating MUST exceed maximum pressure rating of unit.

Check Detergent Siphoning Tube

Examine the filter on the detergent tube and clean if clogged. The tube should fit tightly on the barbed fitting. Examine the tube for leaks or tears. Replace the filter or tube if either is damaged.

Check Gun and Nozzle Extension



Examine the hose connection to the spray gun and make sure it is secure. Test the trigger by pressing the red button and making sure the trigger "springs back" into place when you release it. You should not be able to press the trigger without pressing the red button. Replace spray gun immediately if it fails any of these tests.

SERVICE PRESSURE WASHER

Nozzle Maintenance

A pulsing sensation felt while squeezing the spray gun trigger may be caused by excessive pump pressure. The principal cause of excessive pump pressure is a spray tip clogged or restricted with foreign materials, such as dirt, etc. To correct the problem, immediately clean the spray tip following these instructions:

1. Shut off engine and turn off water supply.
2. ALWAYS point spray gun in a safe direction, press red button and squeeze spray gun trigger to release retained high water pressure.

 WARNING	
	The high pressure stream of water that this equipment produces can cut through skin and its underlying tissues, leading to serious injury and possible amputation.
	Spray gun traps high water pressure, even when engine is stopped and water is disconnected, which can cause injury.
<ul style="list-style-type: none">• Keep high pressure hose connected to pump and spray gun while system is pressurized.• ALWAYS point spray gun in safe direction, press red button and squeeze spray gun trigger, to release high pressure, every time you stop engine.	

3. Remove spray tip from end of nozzle extension.
4. Use a small paper clip to free any foreign material clogging or restricting spray tip (A).

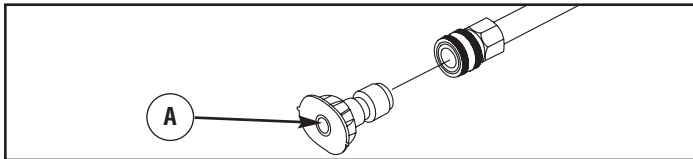

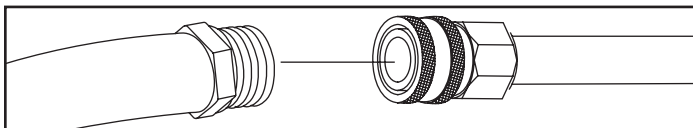

5. Remove nozzle extension from spray gun.
6. Using a garden hose, remove additional debris by back flushing water through nozzle extension. Back flush between 30 to 60 seconds.



7. Reinstall spray tip into nozzle extension.
8. Reconnect nozzle extension to spray gun.
9. Make sure garden hose is connected to water inlet. Check that high pressure hose is connected to spray gun and pump. Turn on water.
10. Start engine following instructions *How to Start Your Pressure Washer*.
11. Test pressure washer by operating with each quick connect spray tip.

O-Ring Maintenance

Purchase an O-Ring/Maintenance Kit, Model 6048, by contacting the nearest authorized dealer. It is not included with the pressure washer. This kit includes replacement o-rings, rubber washer and water inlet filter. Refer to the instruction sheet provided in the kit to service your unit's o-rings.

 WARNING	
	The high pressure stream of water that this equipment produces can cut through skin and its underlying tissues, leading to serious injury and possible amputation.
	<ul style="list-style-type: none">• NEVER repair leaking connections with sealant of any kind. Replace o-ring or seal.

Pump Oil Maintenance

Changing Pump Oil

Change oil after first 50 hours of operation and then every 200 hours or 3 months, whichever occurs first.

NOTE: When changing pump oil, use only high quality nondetergent 30 weight oil. Use no special additives.

Change pump oil as follows:

1. Clean area around brass oil drain plug at bottom of pump.
2. Remove oil drain plug. Drain oil completely into an approved container.
3. When oil has completely drained, install oil drain plug and tighten firmly.
4. Clean area around pump oil dipstick. Remove dipstick and fill pump with recommended oil (approximately 9.6 oz.) to "Full" mark on dipstick.
5. Install pump oil dipstick.
6. Wipe up any spilled oil.

Engine Maintenance

See the engine operator's manual for instructions on how to properly maintain the engine.

 CAUTION	
Avoid prolonged or repeated skin contact with used motor oil.	
<ul style="list-style-type: none">• Used motor oil has been shown to cause skin cancer in certain laboratory animals.• Thoroughly wash exposed areas with soap and water.	



KEEP OUT OF REACH OF CHILDREN. DON'T POLLUTE. CONSERVE RESOURCES. RETURN USED OIL TO COLLECTION CENTERS.

TROUBLESHOOTING

Using Troubleshooting Chart

If you are experiencing a problem that is not listed in this chart, see your authorized dealer for service.

When you have checked all the possible cause listed and you are still experiencing the problem, see your authorized dealer.

Troubleshooting Chart

Problem	Cause	Correction
Pump has following problems: failure to produce pressure, erratic pressure, chattering, loss of pressure, low water volume.	<ol style="list-style-type: none"> 1. Low pressure spray tip installed. 2. Water inlet is blocked. 3. Inadequate water supply. 4. Inlet hose is kinked or leaking. 5. Clogged inlet hose screen. 6. Water supply is over 100°F (38°C). 7. High pressure hose is blocked or leaks. 8. Spray gun leaks. 9. Spray tip is obstructed. 10. Pump is faulty. 	<ol style="list-style-type: none"> 1. Replace with high pressure spray tip. 2. Clear inlet. 3. Provide adequate water flow. 4. Straighten inlet hose, patch leak. 5. Check and clean inlet hose screen. 6. Provide cooler water supply. 7. Clear blocks in outlet hose. 8. Replace spray gun. 9. Clean spray tip. 10. Contact local service facility.
Detergent fails to mix with spray.	<ol style="list-style-type: none"> 1. Detergent siphoning tube is not submerged. 2. Detergent siphoning tube/filter is clogged or cracked. 3. High pressure spray tip installed. 	<ol style="list-style-type: none"> 1. Insert detergent siphoning tube into detergent. 2. Clean or replace filter/detergent siphoning tube. 3. Replace with low pressure spray tip.
Engine runs good at no-load but "bogs" when load is added.	Engine speed is too slow.	Move throttle control to FAST position. If engine still "bogs down", contact local service facility.
Engine will not start; or starts and runs rough.	<ol style="list-style-type: none"> 1. Low oil level. 2. Dirty air cleaner. 3. Out of fuel. 4. Stale fuel. 5. Spark plug wire not connected to spark plug. 6. Bad spark plug. 7. Water in fuel. 8. Excessively rich fuel mixture. 	<ol style="list-style-type: none"> 1. Fill crankcase to proper level. 2. Clean or replace air cleaner. 3. Fill fuel tank. 4. Drain fuel tank; fill with fresh fuel. 5. Connect wire to spark plug. 6. Replace spark plug. 7. Drain fuel tank; fill with fresh fuel. 8. Contact local service facility.
Engine shuts down during operation.	Out of fuel.	Fill fuel tank.
Engine lacks power.	Dirty air filter.	Replace air filter.

STORAGE

Winter Storage

NOTICE

You must protect your unit from freezing temperatures.

- Failure to do so will permanently damage your pump and render your unit inoperable.
- Freeze damage is not covered under warranty.

To protect the unit from freezing temperatures:

1. Follow steps 1-5 in the previous section *After Each Use*.
2. Use pump saver, Model 6039, to treat pump. This minimizes freeze damage and lubricates pistons and seals.
3. If pump saver is not available, connect a 3 ft. section of garden hose to water inlet adapter. Pour RV-antifreeze (antifreeze without alcohol) into hose. Pull recoil handle twice. Disconnect 3 ft. hose.
4. Store unit in a clean, dry area.

Long Term Storage

If you do not plan to use the pressure washer for more than 30 days, you must prepare the engine and pump for long term storage.

Protect Fuel System

Fuel Additive:

Fuel will become stale when stored over 30 days. Stale fuel causes acids and gum deposits to form in the fuel system or on essential carburetor parts. Prior to storage, if gasoline has not been treated with a fuel stabilizer, it must be drained from the engine into an approved container. Then run engine until it stops from lack of fuel.

When fuel stabilizers are used according to their instructions, there is no need to drain the gasoline from the engine prior to storage. Use Briggs & Stratton FRESH START™ fuel stabilizer. Run the engine for a short time to circulate stabilizer throughout the fuel system. Engine and fuel can then be stored up to 24 months.

If gasoline is drained, the use of a fuel stabilizer in the storage container is still recommended to maintain freshness.

Storing the Engine

See the engine operator's manual for instructions on how to properly prepare the engine for storage.

Protecting the Pump

To protect the pump from damage caused by mineral deposits or freezing, use PumpSaver, Model 6039, to treat pump. This prevents freeze damage and lubricates pistons and seals.

NOTICE

You must protect your unit from freezing temperatures.

- Failure to do so will permanently damage your pump and render your unit inoperable.
- Freeze damage is not covered under warranty.

NOTE: PumpSaver is available as an optional accessory. It is not included with the pressure washer. Contact the nearest authorized dealer to purchase PumpSaver.

To use PumpSaver, make sure the pressure washer is turned off and disconnected from supply water. Read and follow all instructions and warnings given on the PumpSaver container.

Other Storage Tips

1. DO NOT store fuel from one season to another unless it has been treated as described in *Protect Fuel System*.
2. Replace fuel container if it starts to rust. Rust and/or dirt in fuel can cause problems if it's used with this unit.
3. Cover unit with a suitable protective cover that does not retain moisture.



WARNING



Storage covers can be flammable.

- DO NOT place a storage cover over a hot pressure washer.
- Let equipment cool for a sufficient time before placing the cover on the equipment.

4. Store unit in a clean and dry area.

WARRANTY

JOHN DEERE® PRESSURE WASHER OWNER WARRANTY POLICY

Effective December 1, 2006 replaces all undated Warranties and all Warranties dated before December 1, 2006

LIMITED WARRANTY

John Deere® and the leaping deer logo are registered trademarks of Deere & Co. and are used under license to Briggs & Stratton Power Products. Briggs & Stratton Power Products Group, LLC will repair or replace, free of charge, any part(s) of the pressure washer that is defective in material or workmanship or both. Read *Other Exclusions* below. Transportation charges on product submitted for repair or replacement under this warranty must be borne by purchaser. This warranty is effective for the time periods and subject to the conditions stated below. For warranty service, find the nearest Authorized Service Dealer in our dealer locator map at BRIGGSandSTRATTON.COM.

THERE IS NO OTHER EXPRESS WARRANTY. IMPLIED WARRANTIES, INCLUDING THOSE OF MERCHANTABILITY AND FITNESS FOR A PARTICULAR PURPOSE, ARE LIMITED TO ONE YEAR FROM PURCHASE, OR TO THE EXTENT PERMITTED BY LAW. ANY AND ALL IMPLIED WARRANTIES ARE EXCLUDED. LIABILITY FOR INCIDENTAL OR CONSEQUENTIAL DAMAGES ARE EXCLUDED TO THE EXTENT EXCLUSION IS PERMITTED BY LAW. Some states or countries do not allow limitations on how long an implied warranty lasts, and some states or countries do not allow the exclusion or limitation of incidental or consequential damages, so the above limitation and exclusion may not apply to you. This warranty gives you specific legal rights and you may also have other rights which vary from state to state or country to country.

WARRANTY PERIOD

Consumer Use	2 years
Commercial Use	90 days

The warranty period begins on the date of purchase by the first retail consumer or commercial end user, and continues for the period of time stated above. "Consumer use" means personal residential household use by a retail consumer. "Commercial use" means all other uses, including use for commercial, income producing or rental purposes. Once equipment has experienced commercial use, it shall thereafter be considered as commercial use for purposes of this warranty.

NO WARRANTY REGISTRATION IS NECESSARY TO OBTAIN WARRANTY ON BRIGGS & STRATTON PRODUCTS. SAVE YOUR PROOF OF PURCHASE RECEIPT. IF YOU DO NOT PROVIDE PROOF OF THE INITIAL PURCHASE DATE AT THE TIME WARRANTY SERVICE IS REQUESTED, THE MANUFACTURING DATE OF THE PRODUCT WILL BE USED TO DETERMINE THE WARRANTY PERIOD.

ABOUT YOUR WARRANTY

We welcome warranty repair and apologize to you for being inconvenienced. Any Authorized Service Dealer may perform warranty repairs. Most warranty repairs are handled routinely, but sometimes requests for warranty service may not be appropriate. For example, warranty service would not apply if equipment damage occurred because of misuse, lack of routine maintenance, shipping, handling, warehousing or improper installation. Similarly, the warranty is void if the manufacturing date or the serial number on the pressure washer or engine has been removed or the equipment has been altered or modified. During the warranty period, the Authorized Service Dealer, at its option, will repair or replace any part that, upon examination, is found to be defective under normal use and service. This warranty will not cover the following repairs and equipment:

- **Normal Wear:** Outdoor Power Equipment, like all mechanical devices, needs periodic parts and service to perform well. This warranty also does not cover normal maintenance such as air filters, adjustments, fuel system cleaning and obstruction (due to chemical, lime, dirt, and so forth).
- **Installation and Maintenance:** This warranty does not apply to equipment or parts that have been subjected to improper or unauthorized installation or alteration and modification, misuse, negligence, accident, overloading, overspeeding, improper maintenance, repair or storage so as, in our judgment, to adversely affect its performance and reliability. This warranty also does not cover normal maintenance such as air filters, adjustments, fuel system cleaning and obstruction (due to chemical, lime, dirt, and so forth).
- **Other Exclusions:** This warranty excludes wear items such as quick couplers, seals, o-rings, pumps that have been run without water supplied or damage or malfunctions resulting from accidents, abuse, modifications, alterations, or improper servicing or freezing or chemical deterioration. Accessory parts, such as guns, hoses, nozzle extensions (wands), and nozzles, are excluded from the product warranty. This warranty excludes used, reconditioned, and demonstration equipment and failures due to acts of God and other force majeure events beyond the manufacturers control.

201605E, Rev. -, 1/10/2007

BRIGGS & STRATTON POWER PRODUCTS GROUP, LLC
JEFFERSON, WI, USA