

EDGESTAR<sup>®</sup>

# Kegeerator Conversion Cooler

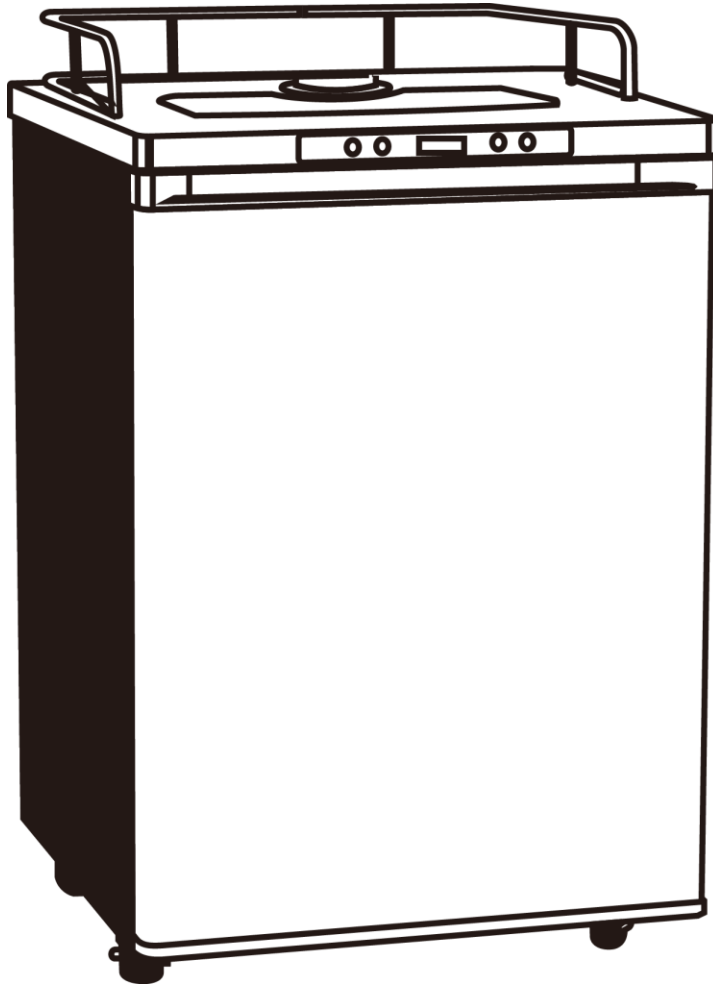

## BR3002BL/BR3002SS

*Fridge for the KC3000 Kegeerators*

### Owner's Manual

For more information on other great EdgeStar products on the web, go to <https://www.edgestar.com>  
To use the EdgeStar self-diagnostic tool, go to <https://support.edgestar.com>

# Important Safety Information

Improper handling can cause serious damage to the EdgeStar kegerator and/or injury to the user. This kegerator is designed for domestic indoor use only. **Do not use the unit for industrial or commercial use.** Any other use may invalidate the warranty. Please review the rating label located on the rear panel of the unit for electrical and other technical data related to this unit. The unit must be used in a properly grounded wall outlet.

**Please read and follow the safety information listed below to reduce the risk of fire, electric shock, or injury.**



## Electrical Safety

- Do not exceed the power outlet ratings.
- It is recommended the kegerator be connected on its own circuit.
- The unit must be installed in accordance with state and local electrical codes.
- A standard electrical supply (115V, 60Hz), that is properly grounded in accordance with the National Electrical Code and local codes and ordinances is required.
- Use outlets that cannot be turned off by a switch or pull chain.
- Always turn the unit off and unplug it from the outlet when cleaning.
- Unplug the unit if it is not going to be used for an extended period of time.
- Do not operate the unit with a power plug missing the ground plug, a damaged cord, or a loose socket.
- Be sure the kegerator is properly grounded.
- Never plug or unplug the unit with wet hands.
- Do not bypass, cut, or remove the grounding plug.
- Do not use extension cords or power strips with this unit. You may need to contact your electrician if it is necessary to use a longer cord or if you do not have a grounded outlet. Do not modify the power cord's length or share the outlet with other appliances.
- Do not start or stop the unit by switching the circuit's power on and off.
- If the power cord is damaged, it must be replaced by the manufacturer or a qualified technician.
- Never repair the unit while it is plugged in.
- Immediately unplug the unit if it makes strange sounds, emits smells, or smoke comes out of it, and contact customer service.
- Do not remove any part of the casing unless instructed by an authorized technician.
- You should never attempt to repair the unit yourself.
- Contact customer service for service options if the unit needs service.



**NOTE:** Flammable Refrigerant Used! When handling, moving, and using the refrigerator: make sure to avoid either damaging the refrigerant tubing, or increasing the risk of a leak.



## General Safety

- To prevent back and other types of injuries, use at least two people to move and install the kegerator.
- This appliance is not intended for use by persons, including children, with reduced physical, sensory or mental capabilities, unless they have been given supervision or instruction concerning the use of the appliance by the person(s) responsible for their safety.
- Install the kegerator in a well-ventilated area where the ambient temperature is above 50°F and below 95°F.
- The temperature range for this kegerator is optimized for beverage storage and dispensing. Perishable food items require a different storage environment.
- Do not place hot or warm items into the kegerator before they cool down to room temperature.
- This unit is designed to be installed indoors, and protected from rain, sleet, snow, and/or moisture.
- This unit is not intended to be used by children.
- Children should be supervised to ensure that they do not play with this product.
- Never allow children to crawl inside the kegerator. If disposing the unit, remove the door.
- Do not use this appliance near flammable gas or combustibles, such as gasoline, benzene, thinner, etc.
- Do not place the unit near heat sources such as ovens, grills, or direct sunlight.
- Only use in an upright position on a flat, level surface and provide proper ventilation.
- Do not pinch or kink the power supply line between the unit and cabinet.
- Do not leave any cleaning solutions in the unit.
- Do not use solvent-based cleaning agents or abrasive solutions to clean the unit as they may damage the interior and exterior.
- Do not place any other appliances on top of the unit.
- Do not turn the unit upside down, on its side or at an angle off level.
- If your model kegerator is equipped with a lock, take care to keep the keys away from children.
- Do not move the unit without emptying the contents and securing the door in a closed position.



**NOTE:** This owner's manual is provided for reference use only. Specifications may change without prior notice. Refer to the product label on the back of your kegerator for the latest technical information.

# Table of Contents

IMPORTANT SAFETY INFORMATION .....	I
TABLE OF CONTENTS .....	III
FIRST TIME OPERATING INSTRUCTIONS .....	IV
INTRODUCTION .....	1
PARTS IDENTIFICATION .....	2
<i>Accessories</i> .....	3
INSTALLING THE KEGERATOR .....	4
<i>Unpacking the Kegerator</i> .....	4
<i>Electrical Requirements</i> .....	5
<i>Leveling the Kegerator</i> .....	6
<i>Installing the Guardrail</i> .....	6
<i>Installing the Casters</i> .....	6
OPERATION .....	6
<i>Installation Check List before Operation</i> .....	6
<i>Using the Temperature Control Panel</i> .....	7
<i>Normal Sounds</i> .....	8
<i>Preparing the Kegerator for Storage</i> .....	8
CLEANING AND MAINTENANCE .....	9
<i>Exterior Cleaning</i> .....	9
<i>Interior Cleaning</i> .....	9
TROUBLESHOOTING .....	10
<i>Before Calling for Help</i> .....	10
<i>Troubleshooting continued</i> .....	11
SPECIFICATIONS .....	12
EDGE STAR LIMITED WARRANTY .....	13

# First Time Operating Instructions

Before use, make sure all packaging labels and materials are all removed from the unit. Be sure to keep track of all included parts and pieces before discarding packaging materials. It is advised that you keep the original box and packaging materials in case you are ever to move or ship the appliance in the future.

Let the unit stand for at least 24 hours before you use it; this allows the cooling components time to settle from transit. The instruction manual should be read before use.

**This owner's manual is provided for reference use only. Specifications may change without prior notice. Refer to the product label on the back of your kegerator for the latest technical information.**

# Introduction

Thank you for purchasing this EdgeStar kegerator. We are glad you chose us. We believe that your purchase of this product opens a relationship between you and EdgeStar. We will provide the customer support needed to nurture that relationship.

This manual contains important information regarding the proper installation, use and maintenance of your kegerator. Following this manual will ensure that your product will work at its peak performance and efficiency.

Please save the original product packaging in case you need to safely transport your kegerator.

## For Your Records:

Please write down the model number and serial number below for future reference. Both numbers are located on the ratings label on the back of your unit and are needed to obtain warranty service. You may also want to staple your receipt to this manual as it is the proof of your purchase, and is also needed for service under your warranty.

Model Number:

\_\_\_\_\_

Serial Number:

\_\_\_\_\_

Date of Purchase:

\_\_\_\_\_

To better serve you, please do the following before contacting customer service:

- If you received a damaged product, immediately contact the retailer or dealer that sold you the product.
- Read and follow this instruction manual carefully to help you install, use and maintain your kegerator.
- Read the troubleshooting section of this manual as it will help you diagnose and solve common issues.
- Visit us on the web at <http://www.edgestar.com> to register your product, download product guides, additional troubleshooting resources and up-to-date information.
- If you need warranty service, our friendly customer service representatives are available via email at [service@edgestar.com](mailto:service@edgestar.com).

# Parts Identification

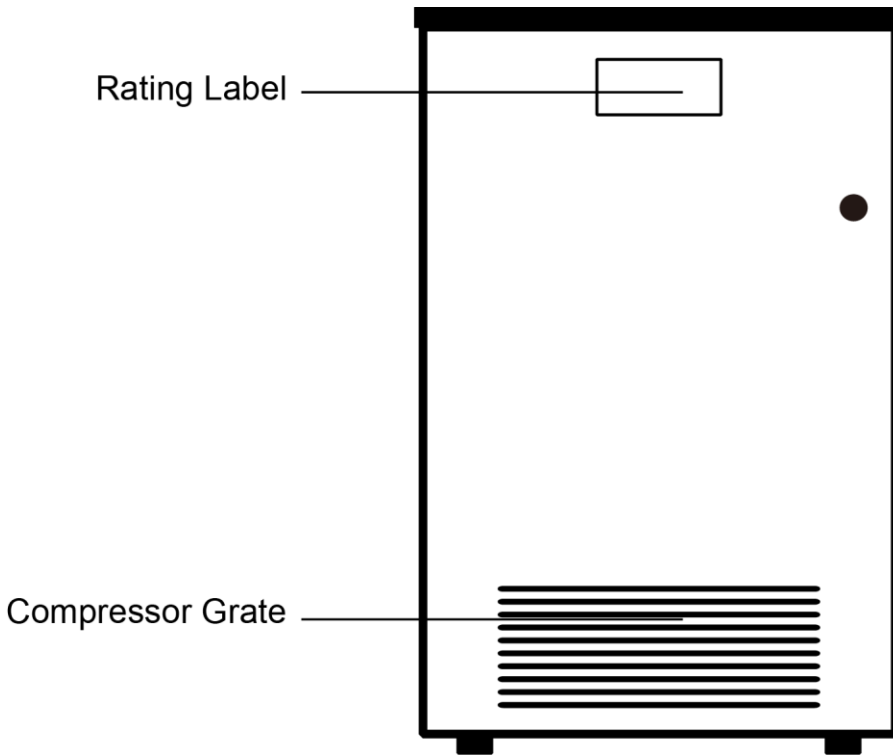
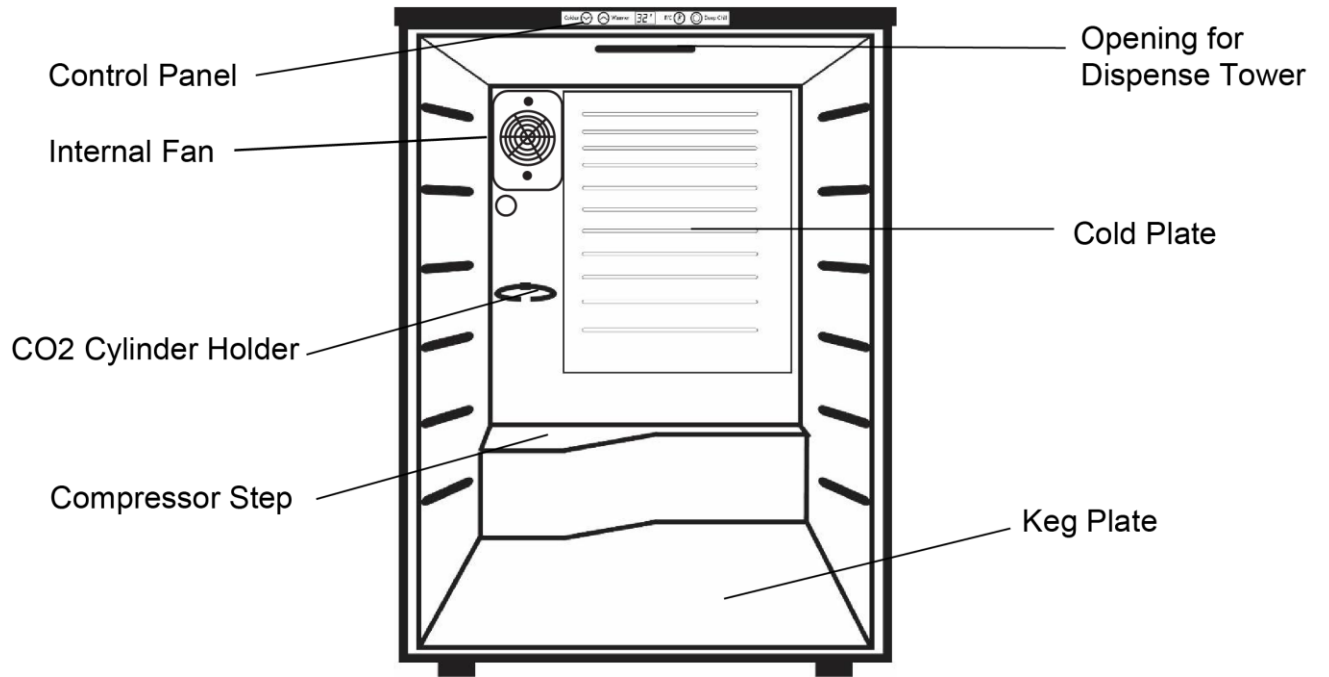

## Accessories

Your kegerator will come with a set of standard accessories. These include a drip tray, guard rail, and casters. The other accessories you receive for the dispense kit and CO2 tank will be based upon the type of kegerator you purchase.

### Standard Accessories:



1 – Drip Tray



1 – Guard Rail

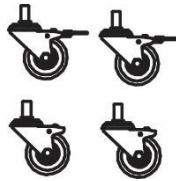

4 – Casters



#### NOTE:

- The type of kegerator you purchase will determine the type of accessories you will receive for the dispense kit. The most common options include single, dual, and triple taps.
- Installation instructions for the dispense kits are provided at the end of this manual.



# Installing the Kegerator

To ensure the kegerator will last, install it in a location where there is proper air circulation and electrical connections. Keep the refrigerator away from heat and direct sunlight. This cooler is designed for indoor use only and should not be used outdoors. It should **not** be placed in a built-in or recessed area as it is designed to be a freestanding kegerator.

The following dimensions are the recommended clearances around the beer dispenser:

- Sides - 4" (76mm)
- Back - 4 to 5" (127 mm)



**NOTE:** This appliance is designed for "indoor" use only and should not be used outdoors.

The kegerator should be installed in accordance with local electrical code requirements. The kegerator should also be placed in a location that is strong enough to support its total weight, keeping in mind that it will weigh substantially more when fully loaded than when empty.

Before you plug the kegerator into a power supply, be sure to let it stand upright for at least 24 hours to allow the compressor's oils to settle.

## *Unpacking the Kegerator*



**WARNING:** Use two more people to move and install the kegerator. Failure to do so can result in back or other injury. Carefully remove the packaging materials. Remove any shipping tape and glue from your kegerator before using. Do not use sharp instruments, rubbing alcohol, flammable fluids, or abrasive cleaners to remove tape or glue. These products can damage the surface of your kegerator.



**IMPORTANT:** Do not remove any safety, warning, or product information labels from your kegerator.

## **Electrical Requirements**



### **ELECTRIC SHOCK HAZARD!**

- Plug into a grounded 3-prong outlet.
- Never remove the grounding prong from the plug.
- Never use an adapter to bypass the grounding prong.
- DO NOT use an extension cord.
- Failure to follow these instructions can result in fire, electrical shock, or death.

Before you move your kegerator into its final location, it is important to make sure you have the proper electrical connection:

A standard electrical supply (115V, 60Hz), properly grounded in accordance with the National Electrical Code and local codes and ordinances, is required.

It is recommended that a separate circuit, serving only your kegerator, be provided. Use receptacles that cannot be turned off by a switch or pull chain. The fuse (or circuit breaker) size should be 15 Amps.

### **Recommended grounding method**

For your personal safety, this appliance's plug must be grounded. It is equipped with a 3-prong power supply cord. To minimize possible shock hazard, the cord must be plugged into a mating 3-prong wall socket and grounded in accordance with the National Electrical Code as well as local codes and ordinances. In the event of a malfunction or breakdown, grounding will reduce the risk of electric shock by providing a path of least resistance for electrical current.

- Plug your appliance into an exclusive, properly installed, grounded wall outlet. Do not, under any circumstances, cut or remove the third (ground) prong from the power cord.
- Any questions concerning power and/or grounding should be directed toward a certified electrician.
- This appliance requires a standard 110~120 volt, 60Hz electrical outlet with three-prong ground.
- Do not use outlet adaptors. No other appliance should be plugged into the same outlet. Be sure that the plug is fully inserted into the outlet.

## ***Leveling the Kegerator***

It is important for the kegerator to be leveled for optimum efficiency. It can be raised or lowered by rotating the two front leveling legs of the cooler. If you find that the surface is not level, rotate the feet until the kegerator becomes level. You may need to make several adjustments to level it.

1. If available, place a carpenter's level on top of the product to see if the kegerator is level from front to back and side to side.
2. To adjust the height of the kegerator, simply turn the feet (Right = Lower / Left = Raise)



**Important:** Please ensure the kegerator is level before installation.

## ***Installing the Guardrail***

Snap the guardrail into the top of the cabinet's guardrail pilot holes.

## ***Installing the Casters***

This unit comes with four (4) casters. These are an optional accessory to assemble if you would like to make the unit more mobile. To install the casters:

1. Remove the two leveling legs from the bottom of the unit.
2. With the contents inside the cabinet removed, set the beer dispenser on its side.
3. Screw in the threaded caster to attach it to the cabinet.
4. With all four casters tightened evenly, stand the unit in an upright position.

# **Operation**

## ***Installation Check List before Operation***

- Have all packing materials and tape been removed from the interior and exterior of the kegerator?
- Have the installation instructions been followed, including connecting the machine to electricity? And has proper grounding been installed for the kegerator?
- Has the machine been leveled?
- Is the kegerator in a site where the ambient temperature is between 50°F and 95°F all year round?

## Using the Temperature Control Panel



This kegerator has an electronic control panel located on the top of the exterior of the cabinet. This kegerator has a cooling range of 32-50°F (0-10°C).

Press the **Cooler** or **Warmer** buttons to adjust temperature by 1°.

Press the **F/C** button to switch between degrees Fahrenheit and Celsius.

Press **Deep Chill** to activate the quick cooling feature of this kegerator. Press the button again to exit Deep Chill mode. Deep Chill should be used to quickly cool a warm kegerator. The machine will operate continuously for 24 hours and exit this mode after 24 hours. Only use this mode when cooling a warm keg.

### Error Codes

- E1: Temperature sensor failure in the refrigerated zone.
- E4: Defrosting sensor failure in refrigerator compartment.
- E7: Ambient temperature sensor fault.



**Caution:** If you powered off the unit, please wait at least 5 minutes before powering it back on.



**Note:** Whether your kegerator can reach cooler temperature depends on the ambient environmental conditions.

## **Normal Sounds**

Your new kegerator may make sounds that are not familiar to you. Most of the new sounds are normal. Hard surfaces like the floor or walls can make the sounds seem louder than they actually are. The following describes the kinds of sounds that might be new to you and what may be making them.

- Rattling noises may come from the flow of the refrigerant or the water line. Items stored on top of the kegerator can also make noises.
- The high efficiency compressor may make a pulsating or high-pitched sound.
- Water running from the evaporator to the water bin may make a splashing or sound.
- As each cycle ends, you may hear a gurgling sound due to the refrigerant flowing in your kegerator.
- Cracking or popping sounds are caused by the expanding and / or contracting of the cooling coils.

## **Preparing the Kegerator for Storage**

If the kegerator will not be used for a long time, or is to be moved to another place, it will be necessary to defrost the unit and dry the interior.

1. Disconnect the unit from the power supply by removing the power plug from the wall socket.
2. Leave the door open to allow for air circulation and to prevent mold, mildew and unpleasant smells.



**Caution:** Store the unit out of the reach of children. If you have children, you may want to take additional precautions such as removing the door to prevent a child from being trapped inside the unit!



**Note:**

- Do not touch the power plug when your hands are wet.
- Never unplug the unit by pulling on the plug.

# CLEANING AND MAINTENANCE

A regular cleaning once every two (2) weeks of the faucet, beer hose, and keg coupler is extremely important when the kegerator is used frequently. If this is not performed, the beer will foam. Additionally, bacteria, yeast, mold, and beer stone will build up and quickly degrade the quality of draft beer. A few minutes spent cleaning on a regular basis will add life to your system, and improve the quality of your draft beer!

## ***Exterior Cleaning***

The door and cabinet may be cleaned with a mild detergent and lukewarm water solution such as 2 tablespoons of baking soda to 1 quart of water.

Do not use solvent based or abrasive cleaners. Use a soft sponge and rinse with clean water. Wipe with a soft clean towel to prevent water spotting. If the door panel is stainless steel, it can discolor when exposed to chlorine gas and moisture. Clean stainless steel with a cloth dampened with a mild detergent and warm water solution. Never use an abrasive or caustic cleaning agent.

## ***Interior Cleaning***

The kegerator's interior should be cleaned occasionally.

1. Disconnect power to the unit.
2. Open the door and remove the contents.
3. Wait until the unit defrosts.
4. With a clean cloth, wipe down the interior of the unit.
5. Reconnect power to the unit.

# TROUBLESHOOTING

## *Before Calling for Help*

If the unit appears to be malfunctioning, read through the OPERATION section of this manual first. If the problem persists, check the Troubleshooting Guide below and on the following page. The problem could be something that can easily be solved or explained.

Symptoms	Possible causes	Solutions
The kegerator turns on and off frequently.	The room temperature is higher than the recommended ambient environment.	Run the unit at the appropriate ambient temperature.
	The door is being opened often.	Minimize the number of times the door is opened.
	The door is not completely closed.	Make sure the door is completely closed.
	The door gasket is not sealing properly.	Make sure the door gasket is properly sealing.
The kegerator does not turn on.	There is a power failure.	Ensure the unit is plugged in and the power outlet has power.
The kegerator does not turn on. The kegerator will not reach the desired temperature	The unit is not plugged in.	Plug the unit in to a power outlet that has sufficient amperage.
	A house fuse has blown or the circuit breaker is tripped.	Replace the broken fuse in your fuse box or reset the breaker.
	The unit is placed too close to a heat source.	Keep the unit away from direct sun light or other heat sources.
The kegerator will not reach the desired temperature The kegerator is making strange noises	The door is opened too frequently or for a long period of time.	Close the door tightly and do not open the door too frequently or for a long period of time.
	Certain sounds are normal.	Read the "Normal Sounds" section.
The kegerator is making strange noises	The unit is not level or is touching another appliance.	Check to make sure that the kegerator is level, and that it is not in contact with another appliance or furniture.

## Troubleshooting continued

Issue	Possible cause	Solution
The body of the kegerator is electrified. Frost is forming in the kegerator.	The unit is not grounded properly.	Contact your local electrician to test your electrical grounding system.
	The environment is humid.	If frost builds up manual defrosting may be required. You can try running the kegerator on a warmer temperature setting, minimizing the number of times you open the door, or unplugging the unit to allow the frost to melt.
	The ambient temperature is too low.	Replace the broken fuse in your fuse box or reset the breaker.
The kegerator will not reach the desired temperature The door will not shut properly.	The door is being opened too frequently.	Keep the unit away from direct sun light or other heat sources.
	Your unit is not level.	Make sure the unit is on a level surface.
The kegerator is making strange noises	The door gasket is dirty.	Clean the door gasket.
	The door gasket is not installed correctly.	Make sure the door gasket is properly installed.
The body of the kegerator is electrified.	The keg plate is not installed correctly	Make sure the keg plate is properly installed.



# Specifications

Description of product	Freestanding Kegerator Conversion Cooler
Model	<b>BR3002BL / SS</b> <i>Fridge for the KC3000 Kegerators</i>
Voltage/Frequency	AC 115V~60Hz
Amperage	0.86A
Color	Black Cabinet; Black or Stainless Steel Door
Storage Capacity Options	<ul style="list-style-type: none"> <li>• 1 Oversized Half Barrel Keg</li> <li>• 1 Half Barrel Keg</li> <li>• 1 Quarter Barrel Keg</li> <li>• 1 Slim Quarter Keg</li> <li>• 1-3 Sixth Barrel Keg(s)</li> <li>• 1-3 Cornelius Keg(s)</li> <li>• 1 Slim Quarter and 1 Sixth Barrel Keg</li> </ul>
Refrigerant	R600a, 1.27 oz.
Dimensions (Height x Width x Depth )	33 1/2" x 23 5/8" x 23 5/8"
Weight	101.4 lbs.



**Note:**

- Technical data and performance information is provided for reference only.
- Specifications are subject to change. Check the rating label on the kegerator for the most accurate information.

# EdgeStar Limited Warranty

## One (1) Year Parts & Labor

This product is warranted by EdgeStar and is subject to any conditions set forth as follows:

### WHAT IS COVERED:

For a period of ONE (1) YEAR from the date of original retail purchase, EdgeStar will repair or replace any part free of charge including labor that fails due to a defect in materials or workmanship. Labor will be performed free of charge at an authorized EdgeStar repair facility and EdgeStar will supply new, rebuilt, or refurbished parts free of charge. EdgeStar may request a defective part be returned in exchange for the replacement part. All replacement parts or products will be new, remanufactured, or refurbished. All products and parts replaced by EdgeStar under warranty service become the property of EdgeStar. After the 12 month period, EdgeStar will no longer be responsible for labor charges incurred or replacement parts. All defective products and parts covered by this warranty will be repaired or replaced on a mail-in basis to an EdgeStar authorized repair facility. This warranty applies to the original purchaser only, and only covers defects in workmanship experienced during operation of the product under normal service, maintenance, and usage conditions. This warranty applies to the purchase and use of this product in residential settings within the contiguous United States of America.

### Exceptions: Commercial or Rental Use

#### Warranty

90 days labor and parts from date of original purchase. No other warranty applies.

WHAT IS NOT COVERED- The following limitations apply to the coverage of this warranty. This warranty does not cover:

- Labor charges for installation, setup, or training to use the product.
- Shipping damage, and any damage caused by improper packaging for shipment to an authorized service center, and any damaged caused by improper voltage or any other misuse, including abnormal service, handling, or usage.
- Cosmetic damage such as scratches and dents.
- Normal wear and tear on parts or replacement of parts designed to be replaced, e.g. filters, cartridges, batteries.
- Service trips to deliver, pick-up, or repair, install the product, or to instruct in proper usage of the product.
- Damages or operating problems resulting from misuse, abuse, operation outside environmental specifications, uses contrary to instructions provided in the owner's manual, accidents, acts of God, vermin, fire, flood, improper installation, unauthorized service, maintenance negligence, unauthorized installation or modification, or commercial use.
- Labor, service transportation, and shipping charges for the removal and replacement of defective parts, beyond the initial 12 month period.
- Products that have been modified to perform outside of specifications without the prior written permission of EdgeStar.
- Products lost in shipment, or theft.
- Products sold AS IS or from an unauthorized reseller.
- Products that have had their serial numbers removed, defaced, or with serial numbers that have been invalidated.
- Damage from other than normal household use.
- Replacement or repair of household fuses, circuit breakers, wiring or plumbing.
- Damage to personal property from use of product.
- Damage from service other than from an authorized EdgeStar repair facility.
- Hoses, knobs, lint trays and all attachments, accessories and disposable parts.
- Any service charges not specifically identified as normal such as normal service area or hours.
- Any special or consequential damages arising out of the use of the product.

OBTAINING WARRANTY SERVICE: If you believe your product is defective, contact EdgeStar Customer Support for troubleshooting assistance and warranty service at [www.edgestar.com](http://www.edgestar.com) or call 1-866-319-5473. Before contacting Customer Support you are required to have your model number, serial number, and proof of purchase available upon request. Once an EdgeStar authorized representative has confirmed that your product is defective and eligible for warranty service, the product must be returned to an EdgeStar authorized repair facility. EdgeStar is not responsible for damage resulting from shipper mishandling or improper packaging. Do not return a defective product to the place of purchase. Products received without a return authorization number will be refused.

THIS WARRANTY IS IN LIEU OF ANY OTHER WARRANTY, EXPRESS OR IMPLIED, INCLUDING WITHOUT LIMITATION, ANY WARRANTY OF MERCHANTABILITY OR FITNESS FOR A PARTICULAR PURPOSE. TO THE EXTENT ANY IMPLIED WARRANTY IS REQUIRED BY LAW, IT IS LIMITED IN DURATION TO THE EXPRESS WARRANTY PERIOD ABOVE. NEITHER THE MANUFACTURER NOR ITS DISTRIBUTORS SHALL BE LIABLE FOR ANY INCIDENTAL, CONSEQUENTIAL, INDIRECT, SPECIAL, OR PUNITIVE DAMAGES OF ANY NATURE, INCLUDING WITHOUT LIMITATION, LOST REVENUES OR PROFITS, OR ANY OTHER DAMAGE WHETHER BASED IN CONTRACT, TORT, OR OTHERWISE. IN NO EVENT AND UNDER NO CIRCUMSTANCE OF ANY TYPE OR KIND SHALL THE SELLER, MANUFACTURER AND/OR DISTRIBUTOR BE LIABLE FOR ANY REASON, UNDER ANY THEORY, FOR MORE THAN THE BASIC COST OF THE PRODUCT TO THE PURCHASER OR END USER. SOME STATES DO NOT ALLOW THE EXCLUSION OF INCIDENTAL OR CONSEQUENTIAL DAMAGES, SO THE ABOVE EXCLUSION MAY NOT APPLY TO YOU. THIS WARRANTY GIVES YOU SPECIFIC LEGAL RIGHTS. YOU MAY HAVE OTHER RIGHTS THAT VARY FROM STATE TO STATE.

# EDGESTAR®

## KC3000/KC3000TWIN/KC3000TRIP Kegerator Installation Guide

\* Dispense parts not included in fridge only BR3 models

\*\* Parts in specialty wine, coffee, kombucha and other models will vary

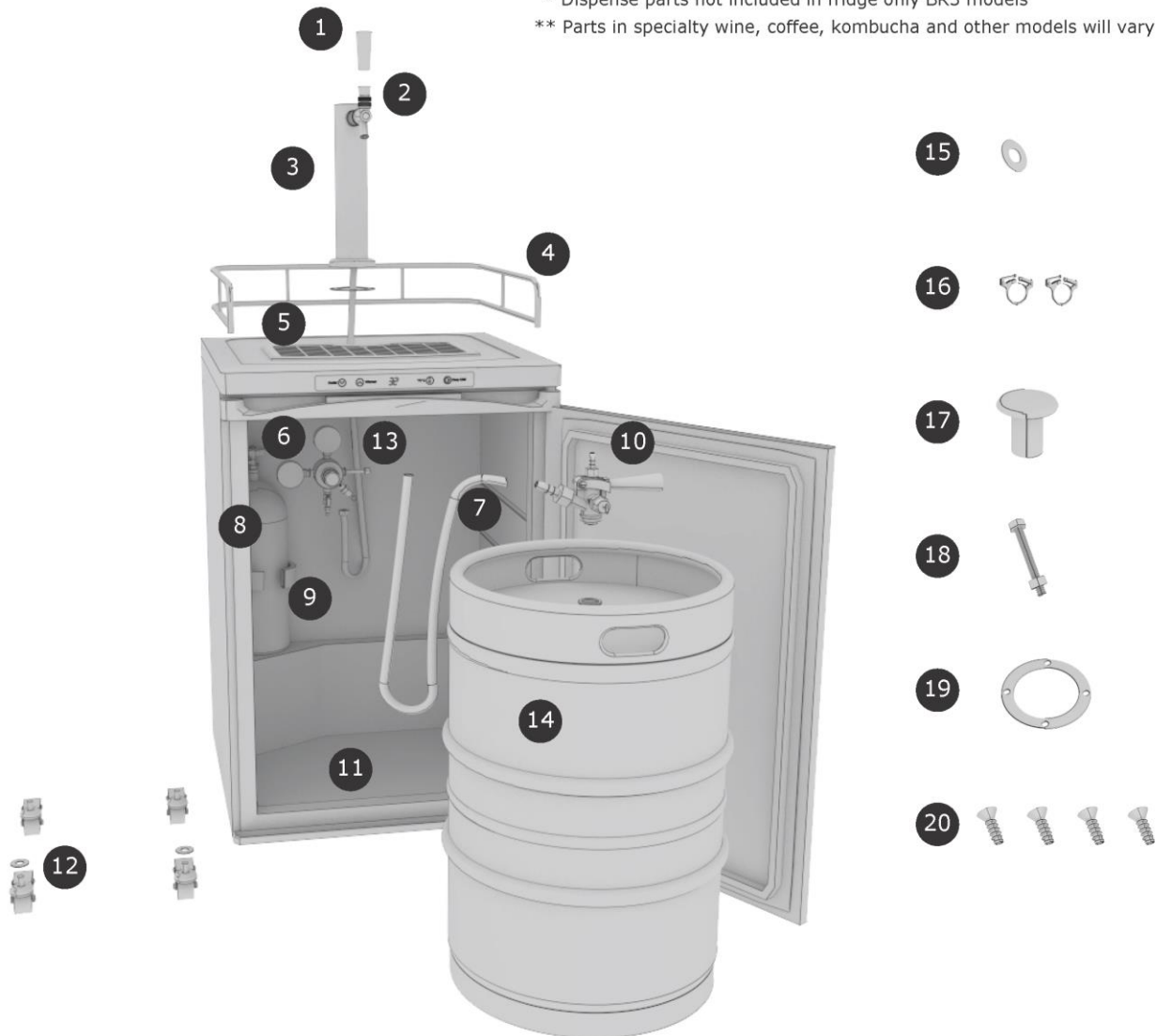

1. Faucet Handle
2. Faucet
3. Beer Tower
4. Guard Rail
5. Drip Tray
6. Regulator
7. CO<sub>2</sub> Tube

8. CO<sub>2</sub> Cylinder (supplied empty)
9. Cylinder Clip
10. American Sankey Keg Coupler
11. Metal Keg Floor Support
12. Casters (x4) and Washers (x2)
13. Beer Line
14. Half Barrel Keg (not included)

15. Neoprene Washer
16. Hose Clamps (2)
17. Tower Plug
18. Long Bolt and Nut
19. Tower Gasket
20. Screws (4)

### Tools Needed:

- Wrench
- Flat Head Screwdriver
- Pair of Pliers/Clamp Crimper

For additional information  
visit [edgestar.com](http://edgestar.com)

# 1

## Install Caster Wheels

Before assembly, make sure to empty the inside of the unit including all shelves and metal keg floor (# 11). Carefully lay the unit on its back. Attach the casters (#12) into the existing holes at the bottom of the unit. The front two casters require a flat washer (part# 12) prior to installation. Next, set the unit upright and reinstall the keg floor (# 11).

**Note:** Allow the dispenser to stand in an upright position for 24 hours before plugging in the unit.



# 2

## Remove Plug

Carefully remove the tower plug (#17) located on the top of the unit by opening the cabinet, and with your hand, push plug through the top of the cabinet from the inside. Use flat head screwdriver as a prying tool if necessary.



# 3

## Install Tower

Mount the tower gasket (#19) by lining it up with the preexisting holes at the top of the unit. Install the tower (#3) by first unraveling the beer line from the bottom of the tower. Feed the beer line (#13) through the top opening that was under the cabinet plug.



# 4

## Secure Tower

Once the beer line is fed into the unit line up the holes at the bottom of the tower and install the four screws (#20).



# 5

## Install Handle & Faucet

Screw the faucet handle (#1) to the beer faucet (#2). Line up the beer faucet to the tower shank at the front of the tower (#3) and tighten the collar.



# 6

## Install Railing

Take the railing (#4) and slide its "feet" into the pilot holes in the top of the cabinet.



### Warning:

CO<sub>2</sub> can be dangerous! CO<sub>2</sub> cylinders contain high-pressured gas, which can be hazardous if handled improperly. Please handle with care.

# 7

## Connect Regulator to Cylinder

Attach the CO<sub>2</sub> regulator (#6) to the CO<sub>2</sub> cylinder (#8) by screwing the regulator nut onto the cylinder valve and tightening with pliers.

**Note:** A fiber washer is normally required to connect a regulator to a CO<sub>2</sub> cylinder, but the standard regulator provided includes a built-in o-ring.



# 8

## Connect Tube to Regulator

Make sure the shut off valve at the bottom of the regulator is closed (9 o'clock position). Install the CO<sub>2</sub> Tube (#7) to the hose barb at the bottom of the regulator (#6) and secure with a hose clamp (#16).



# 9

## Mount CO<sub>2</sub> Cylinder

Mount the CO<sub>2</sub> cylinder (#8) onto the step and inside the cylinder clip (#9). Secure the tank into the clip using the long bolt and nut (#18).



# 10

## Attach Tube to Coupler

Attach the remaining end of the CO<sub>2</sub> tube (#7) to hose barb on the side of the coupler (#10). Secure the tube with a hose clamp (#16).



# 11

## Connect Beer Line

Now connect the beer line (#13) to the keg coupler (#10). Insert the neoprene washer (#15) into the beer line hex nut (the beer line is the line coming from/going to the tower and faucet). Remove the blue rubber protective cap located on top of the keg coupler and screw the nut with the rubber washer to the top of the keg coupler, hand-tighten firmly.



# 12

## Connect Keg Coupler

To connect the keg coupler (#10) to the keg (#14), first make sure the black pull handle of the keg coupler is in the up position (45° angle). Insert the keg coupler into the valve on top of the keg and turn clockwise until it stops about 90° to lock the coupler into place. Now pull the tap handle out (away from the keg coupler (#10) and push down until it locks into position. Listen for the "click" of the pull handle when it shifts into the final downward position. The keg is now tapped.



### Note:

This manual is intended as a guide for installation. While there are many different ways to install this kit, we recommend you follow these instructions. If you are uncomfortable in your ability to assemble this kit, seek professional assistance.

# 13

## Calibrating the Regulator

- (A) With the shut-off valve on the regulator closed, open the valve on the CO<sub>2</sub> cylinder (#8) completely.
- (B) With a pair of pliers, loosen adjustment nut allowing adjustment screw to be turned counter-clockwise until adjustment screw is completely open.
- (C) Using a flathead screwdriver, slowly turn the regulator adjustment screw clockwise until the desired pressure is shown on the pressure gauge on the top. By turning the screw clockwise it will increase (+) pressure and counterclockwise will decrease (-) pressure. Under normal circumstances, we recommend setting the regulator at 10-12psi. NOTE: When adjusting pressure from a high pressure to a lower pressure, you will need to release the higher pressure out by pulling the manual pressure release valve ring located on the side of the coupler.
- (D) Once the desired pressure is set, open the shut-off valve by turning the lever down (6 o'clock position or parallel to the CO<sub>2</sub> tube). Gas should now be flowing from the regulator to the keg coupler. You will hear the keg pressurizing. The output needle will drop momentarily while the pressure is equalizing. Then, the needle will return to the point you set it at.

**NOTE:** Other conditions, such as altitude, beer type, and temperature may require some adjustment. It is always wise to follow up any adjustment to the regulator with a brief pull of the pressure release valve ring on the regulator or coupler to ensure an accurate output reading.

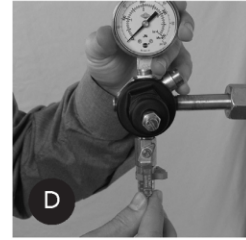
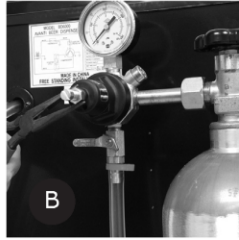
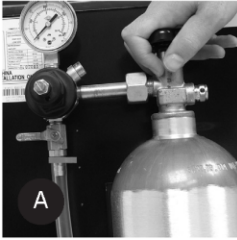

## Multiple Keg Configurations

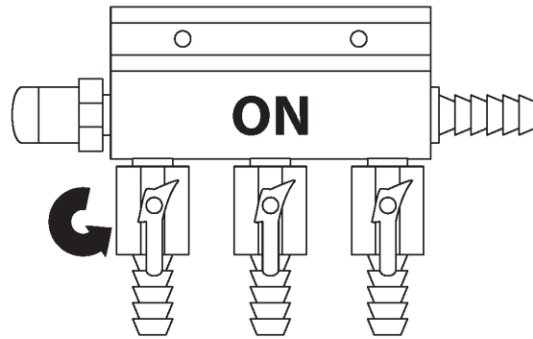
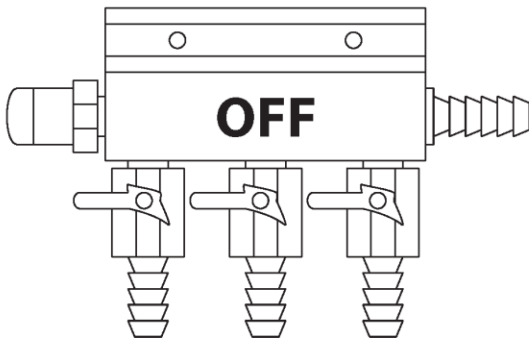
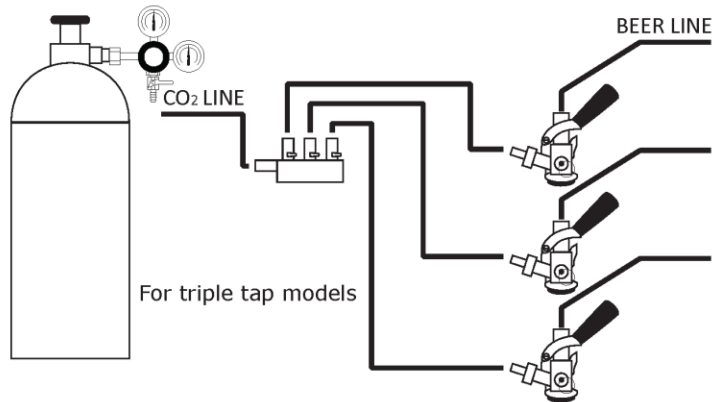
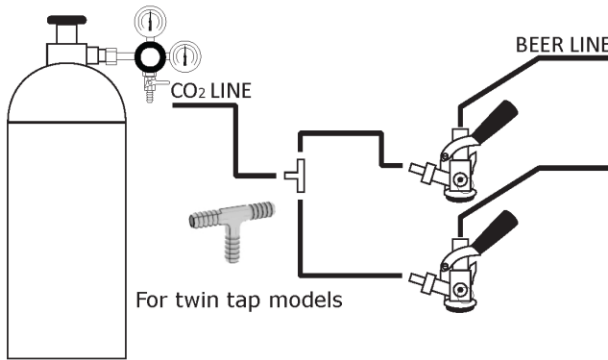

\*Manifold included in triple tap models

### Warning:

This guide is provided for informational purposes only. It is provided as a supplement to the owner's manual. Please refer to the owner's manual for a full discourse on installation, usage and maintenance. If you have any questions about the installation of this appliance, feel free to contact EdgeStar service at 866.319.5473 or consult a qualified installer. Neither the manufacturer nor its distributors shall be liable for any incidental, consequential, indirect, special, or punitive damages of any nature, including without limitation, lost revenues or profits, or any other damage whether based in contract, tort, or otherwise.

Co<sub>2</sub> cylinder comes empty due to HAZMAT restrictions. It will need to be filled locally at any air/gas supplier prior to use.