

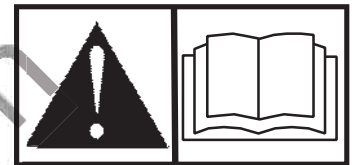

Pressure Washer Operator's Manual



This pressure washer is rated in accordance to the Pressure Washer Manufacturers Association (PWMA) standard PW101-2010 (Testing and Rating Performance of Pressure Washers).



BRIGGS & STRATTON POWER PRODUCTS GROUP, LLC
MILWAUKEE, WISCONSIN, U.S.A.

Manual No. 318555GS Revision -

Thank you for purchasing this quality-built Briggs & Stratton® pressure washer. We are pleased that you've placed your confidence in the Briggs & Stratton brand. When operated and maintained according to the instructions in this manual, your Briggs & Stratton pressure washer will provide many years of dependable service.

This manual contains safety information to make you aware of the hazards and risks associated with pressure washers and how to avoid them. Because Briggs & Stratton does not necessarily know all the applications this pressure washer could be used for, it is important that you read and understand these instructions thoroughly before attempting to start or operate this equipment. **Save these original instructions for future reference.**

This pressure washer requires final assembly before use. Refer to the *Assembly* section of this manual for instructions on final assembly procedures. Follow the instructions completely.

Where to Find Us

You never have to look far to find Briggs & Stratton support and service for your pressure washer. Consult your Yellow Pages. There are over 30,000 Briggs & Stratton authorized service dealers worldwide who provide quality service. You can also contact Briggs & Stratton Customer Service by phone at **(800) 743-4115**, or on the Internet at BRIGGSandSTRATTON.COM.

Pressure Washer

Model Number

--	--	--	--	--	--	--	--

Revision

--	--

Serial Number

--	--	--	--	--	--	--	--	--	--	--	--	--	--	--	--	--	--

Engine

Model Number

--	--	--	--	--	--	--	--

Type Number

--	--	--	--	--	--	--	--

Code Number

--	--	--	--	--	--	--	--	--	--	--	--	--	--	--	--	--	--	--	--

Date Purchased

--	--	--	--	--	--	--	--

Copyright © 2012. Briggs & Stratton Power Products Group, LLC
Milwaukee, WI, USA. All rights reserved.
BRIGGS & STRATTON POWER PRODUCTS is a registered
trademark of Briggs & Stratton Corporation
Milwaukee, WI, USA

Table of Contents

Operator Safety	4
Equipment Description	4
Important Safety Information	4
Assembly	7
Unpack Pressure Washer	7
Attach Accessory Holders	7
Install Wheel Kit	8
Moving Pressure Washer	8
Attach Negative Battery Cable	8
Add Engine Oil	9
Add Fuel	9
Lubricate O-Rings	10
Battery Charger	10
Connect Hose and Water Supply to Pump	11
Features and Controls	12
Operation	13
Pressure Washer Location	13
How to Start Your Pressure Washer	13
How to Stop Your Pressure Washer	15
How to Store Accessories	15
How to Use Spray Tips	16
Applying Detergent	16
Pressure Washer Rinsing	17
Automatic Cool Down System (Thermal Relief)	17
Maintenance	18
Maintenance Schedule	18
Battery Maintenance	18
Fuel Valve Maintenance	18
Pressure Washer Maintenance	19
Engine Maintenance	20
After Each Use	23
Winter Storage	23
Long Term Storage	24
Troubleshooting	25
Warranties	26
Emissions Control System Warranty	26
Pressure Washer Owner Warranty	28
Specifications	30
Product Specifications	30
Common Service Parts	30

Operator Safety

Equipment Description



Read this manual carefully and become familiar with your pressure washer. Know its applications, its limitations, and any hazards involved.

This pressure washer operates at 3,300 PSI and a flow rate of 3.2 gallons per minute. This high quality residential system features 10" wheels, axial cam pump with stainless steel pistons, automatic cool down system, cleaning tank system, quick connect spray tips, heavy duty 50' hose, and more.

Every effort has been made to ensure that information in this manual is accurate and current. However, we reserve the right to change, alter, or otherwise improve the product and this document at any time without prior notice.

The Emission Control System for this pressure washer is warranted for standards set by the Environmental Protection Agency and the California Air Resources Board.

Important Safety Information

Safety Symbols and Meanings



Operator's Manual



Toxic Fumes



Electrical Shock



Slippery Surface



Fall



Fluid Injection



Fire



Explosion



Kickback



Projectile



Moving Parts



Flying Objects



Chemical Burn



Hot Surface

▲ The safety alert symbol indicates a potential personal injury hazard. A signal word (DANGER, WARNING, or CAUTION) is used with the alert symbol to designate a degree or level of hazard seriousness. A safety symbol may be used to represent the type of hazard. The signal word *NOTICE* is used to address practices not related to personal injury.

▲ **DANGER** indicates a hazard which, if not avoided, *will* result in death or serious injury.

▲ **WARNING** indicates a hazard which, if not avoided, *could* result in death or serious injury.

▲ **CAUTION** indicates a hazard which, if not avoided, *could* result in minor or moderate injury.

NOTICE address practices not related to personal injury.

▲ **WARNING POISONOUS GAS HAZARD.** Engine exhaust contains carbon monoxide, a poisonous gas that could kill you in minutes. You **CANNOT** smell it, see it, or taste it. Even if you do not smell exhaust fumes, you could still be exposed to carbon monoxide gas. Some chemicals or detergents could be harmful if inhaled or ingested, resulting in death, serious injury, nausea, fainting or poisoning.

- Operate this product **ONLY** outside far away from windows, doors and vents to reduce the risk of carbon monoxide gas from accumulating and potentially being drawn towards occupied spaces.
- Install battery-operated carbon monoxide alarms or plug-in carbon monoxide alarms with battery back-up according to the manufacturer's instructions. Smoke alarms cannot detect carbon monoxide gas.
- **DO NOT** run this product inside homes, garages, basements, crawlspaces, sheds, or other partially-enclosed spaces even if using fans or opening doors and windows for ventilation. Carbon monoxide can quickly build up in these spaces and can linger for hours, even after this product has shut off.
- **ALWAYS** place this product downwind and point the engine exhaust away from occupied spaces.

If you start to feel sick, dizzy, or weak while using this product, shut it off and get to fresh air **RIGHT AWAY**. See a doctor. You may have carbon monoxide poisoning.

- Use a respirator or mask whenever there is a chance that vapors may be inhaled when using chemicals.
- Read all instructions with mask so you are certain the mask will provide the necessary protection against inhaling harmful vapors when using chemicals.

▲ **WARNING** The engine exhaust from this product contains chemicals known to the State of California to cause cancer, birth defects, or other reproductive harm.

▲ **WARNING** This product contains lead and lead compounds, known to the State of California to cause birth defects or other reproductive harm. *Wash your hands after handling this product.*

 **WARNING** Exhaust heat/gases could ignite combustibles, structures or damage fuel tank causing a fire, resulting in death, serious injury and/or property damage.

Contact with muffler area could cause burns resulting in serious injury.

- DO NOT touch hot parts and AVOID hot exhaust gases.
- Allow equipment to cool before touching.
- Keep at least 5 feet (1.5 m) of clearance on all sides of pressure washer including overhead.
- It is a violation of California Public Resource Code, Section 4442, to use or operate the engine on any forest-covered, brush-covered, or grass-covered land unless the exhaust system is equipped with a spark arrester, as defined in Section 4442, maintained in effective working order. Other states or federal jurisdictions may have similar laws.

Contact the original equipment manufacturer, retailer, or dealer to obtain a spark arrester designed for the exhaust system installed on this engine.

- Replacement parts must be the same and installed in the same position as the original parts.

 **WARNING** Risk of electrocution. Contact with power source could cause electric shock or burn resulting in death or serious injury.

- NEVER spray near power source.

 **WARNING** Use of pressure washer could create puddles and slippery surfaces causing you to fall resulting in death or serious injury. Kickback from spray gun could cause you to fall resulting in death or serious injury.

- Operate pressure washer from a stable surface.
- The cleaning area should have adequate slopes and drainage to reduce the possibility of a fall due to slippery surfaces.
- Be extremely careful if you must use the pressure washer from a ladder, scaffolding, or any other similar location.
- Firmly grasp spray gun with both hands when using high pressure spray to avoid injury when spray gun kicks back.

 **WARNING** Chemical Burn Hazard. Chemicals could cause burns resulting in death, serious injury, and/or property damage.

- DO NOT use caustic liquid with pressure washer.
- Use ONLY pressure washer safe detergents/soaps. Follow all manufacturers instructions.

 **WARNING** Fuel and its vapors are extremely flammable and explosive which could cause burns, fire or explosion resulting in death, serious injury and/or property damage.

WHEN ADDING OR DRAINING FUEL

- Turn pressure washer engine OFF and let it cool at least 2 minutes before removing fuel cap. Loosen cap slowly to relieve pressure in tank.
- Fill or drain fuel tank outdoors.
- DO NOT overfill tank. Allow space for fuel expansion.
- If fuel spills, wait until it evaporates before starting engine.
- Keep fuel away from sparks, open flames, pilot lights, heat, and other ignition sources.
- Check fuel lines, tank, cap and fittings frequently for cracks or leaks. Replace if necessary.
- DO NOT light a cigarette or smoke.

WHEN STARTING EQUIPMENT

- Ensure spark plug, muffler, fuel cap, and air cleaner are in place.
- DO NOT crank engine with spark plug removed.

WHEN OPERATING EQUIPMENT

- DO NOT operate this product inside any building, carport, porch, mobile equipment, marine applications, or enclosure.
- DO NOT tip engine or equipment at angle which causes fuel to spill.
- DO NOT spray flammable liquids.

WHEN TRANSPORTING, MOVING OR REPAIRING EQUIPMENT

- Transport/move/repair with fuel tank EMPTY or with fuel shutoff valve OFF.
- DO NOT tip engine or equipment at angle which causes fuel to spill.
- Disconnect spark plug wire.

WHEN STORING FUEL OR EQUIPMENT WITH FUEL IN TANK

- Store away from furnaces, stoves, water heaters, clothes dryers, or other appliances that have pilot light or other ignition source because they could ignite fuel vapors.

 **WARNING** Starter cord kickback (rapid retraction) will pull hand and arm toward engine faster than you can let go which could cause broken bones, fractures, bruises, or sprains resulting in serious injury.

- NEVER pull starter cord without first relieving spray gun pressure.
- When starting engine, pull cord slowly until resistance is felt and then pull rapidly to avoid kickback.
- After each starting attempt, where engine fails to run, always point spray gun in safe direction, press red button and squeeze spray gun trigger to release high pressure.
- Firmly grasp spray gun with both hands when using high pressure spray to avoid injury when spray gun kicks back.

 **WARNING** The high pressure stream of water that this equipment produces could cut through skin and its underlying tissues, resulting in serious injury and possible amputation.

Spray gun traps high water pressure, even when engine is stopped and water is disconnected, which could result in serious injury.

- If cut by fluid, call physician immediately. DO NOT treat as a simple cut.
- DO NOT allow CHILDREN to operate pressure washer.
- NEVER repair high pressure hose. Replace it.
- NEVER repair leaking connections with sealant of any kind. Replace o-ring or seal.
- NEVER connect high pressure hose to nozzle extension.
- Keep high pressure hose connected to pump and spray gun while system is pressurized.
- ALWAYS point spray gun in safe direction, press red button and squeeze spray gun trigger to release high pressure, every time you stop engine.
- NEVER aim spray gun at people, animals, or plants.
- DO NOT secure spray gun in open position.
- DO NOT leave spray gun unattended while machine is running.
- NEVER use a spray gun which does not have a trigger lock or trigger guard in place and in working order.
- Always be certain spray gun, nozzles and accessories are correctly attached.

 **WARNING** Unintentional sparking could cause fire or electric shock resulting in death or serious injury.

WHEN ADJUSTING OR MAKING REPAIRS TO YOUR PRESSURE WASHER

- Disconnect the spark plug wire from the spark plug and place the wire where it cannot contact spark plug.

WHEN TESTING FOR ENGINE SPARK

- Use approved spark plug tester.
- DO NOT check for spark with spark plug removed.

 **WARNING** Starter and other rotating parts could entangle hands, hair, clothing, or accessories resulting in serious injury.

- NEVER operate pressure washer without protective housing or covers.
- DO NOT wear loose clothing, jewelry or anything that could be caught in the starter or other rotating parts.
- Tie up long hair and remove jewelry.

 **WARNING** Risk of eye or bodily injury. Spray could splash back or propel objects resulting in serious injury.

- Always wear indirect vented (chemical splash) safety goggles marked to comply with ANSI Z87.1 when using or in vicinity of this equipment.
- NEVER substitute safety glasses or dry-condition goggles for indirect vented safety goggles.
- Always wear protective clothing such as a long-sleeved shirt, long pants and close-toed shoes.
- NEVER operate pressure washer when barefoot or wearing sandals or shorts.

 **CAUTION** Excessively high operating speeds could result in minor injury and/or pressure washer damage. Excessively low speeds impose a heavy load.

- DO NOT tamper with governor spring, links or other parts to increase engine speed. Pressure washer supplies correct rated pressure and flow when running at governed speed.
- DO NOT modify pressure washer in any way.

NOTICE High pressure spray could damage fragile items including glass.

- DO NOT point spray gun at glass when using red (0°) spray tip.
- NEVER aim spray gun at plants.

NOTICE Improper treatment of pressure washer could damage it and shorten its life.

- If you have questions about intended use, ask dealer or contact qualified service center.
- NEVER operate units with broken or missing parts, or without protective housing or covers.
- DO NOT by-pass any safety device on this machine.
- DO NOT tamper with governed speed.
- DO NOT operate pressure washer above rated pressure.
- DO NOT modify pressure washer in any way.
- Before starting pressure washer in cold weather, check all parts of the equipment to be sure ice has not formed there.
- NEVER move machine by pulling on hoses. Use handle provided on unit.
- This equipment is designed to be used with Briggs & Stratton Power Products authorized parts **ONLY**. If equipment is used with parts that DO NOT comply with minimum specifications, user assumes all risks and liabilities.

Assembly



Read entire operator's manual before you attempt to assemble or operate your new pressure washer.

Your pressure washer requires some assembly and is ready for use after it has been properly serviced with the recommended oil and fuel.

If you have any problems with the assembly of your pressure washer, please call the pressure washer helpline at **(800) 743-4115**. If calling for assistance, please have the model, revision, and serial number from the identification label available.

Unpack Pressure Washer

1. Remove the parts bag, accessories, and inserts included with pressure washer.
2. Open carton completely by cutting each corner from top to bottom.
3. Ensure you have all included items prior to assembly.

Items in the carton include:

- Main Unit
- High Pressure Hose
- Spray Gun
- Nozzle Extension with Quick Connect Fitting
- Hose Wrap
- Wheels (2)
- Caster Wheels (2)
- Oil Bottle
- Oil Funnel
- Spray Gun Holder Wireform
- Battery Float Charger
- Operator's Manual
- Owner's Registration Card
- Multi-Colored Spray Tips (5)
- Handle Pin
- Axle Studs (2)
- Retaining Pins (2)
- Washers (4)
- Keys (2)
- Metal Spring Clips (2)
- Plastic Knobs (1)
- Screws (5)
- Hex Key Wrench

To prepare your pressure washer for operation, you will need to perform these tasks:

1. Fill out and send in registration card.
2. Attach hose wrap, metal spring clips, spray gun holder wireform and handle pin to main unit.
3. Install wheel kit on main unit.
4. Add oil to engine crankcase.
5. Add fuel to fuel tank.

6. Connect high pressure hose to spray gun and pump.
7. Connect water supply to pump.
8. Attach nozzle extension to spray gun.
9. Select/attach quick connect spray tip to nozzle extension.

Attach Accessory Holders

All assembly instructions in this section will be viewing from engine end of unit.

1. Place hose wrap (A) over holes (B) on end of main unit. Using provided hex key wrench, attach hose wrap with three screws (C). Tighten by hand.

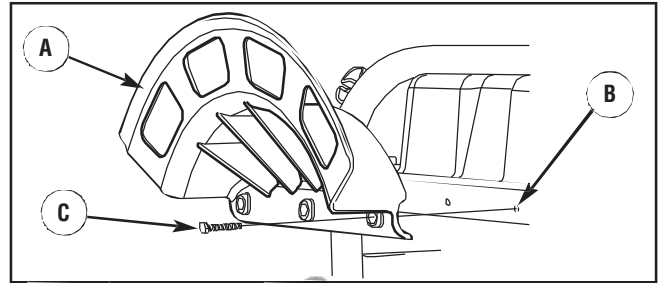

2. Insert spray gun holder wireform (D) through holes on right side of unit frame. Hold wireform in place and attach a plastic knob (E) from inside of unit. Tighten by hand.

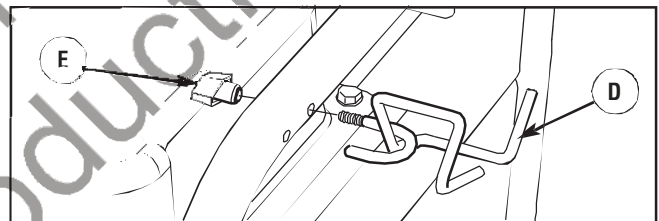

3. Using provided hex key wrench, attach metal spring clips (F) to left side frame of unit with screws (G). Tighten by hand.

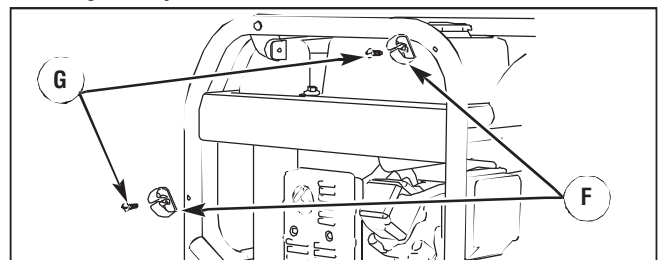

Install Wheel Kit

NOTICE Wheel kit is not intended for over-the-road use.

Install the wheel kit as follows:

1. Lift corner of pressure washer and slide caster wheels up into bottom of tubing on each underside of pressure washer frame.
2. Using a 3/4" (19 mm) wrench, turn nut (A) under collar of caster wheels to tighten.

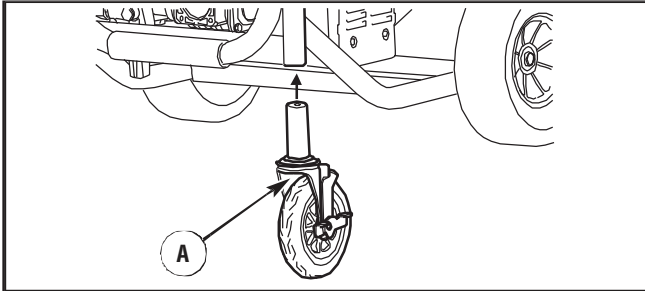

3. Slide flat washer (B), wheel (C) and another flat washer (B) over axle stud (D).

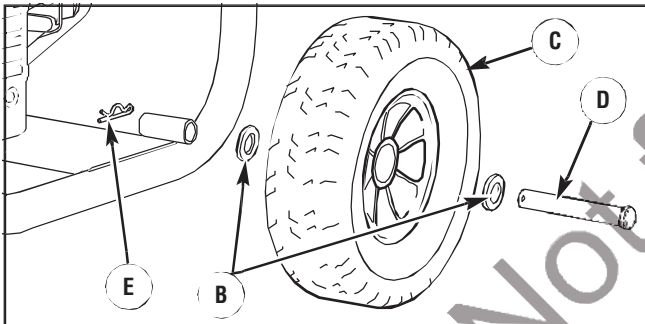

NOTICE Be sure to install wheel with raised hub inboard.

4. Lift corner of pressure washer slightly and slide axle stud through mounting bracket on pressure washer frame.
5. Insert retaining pin (E) through hole on axle stud.
6. Repeat steps 3 through 5 to secure second wheel.

Moving Pressure Washer

The pressure washer is equipped with a handle that locks into three different positions for your convenience. With the handle in the upright position, it makes it easy to push or pull your pressure washer to the desired location. With the handle in the middle position, you can tilt the pressure washer back. The handle also folds down flat for storage.

1. Screw handle pin (F) into bracket on left side of frame (viewing pressure washer from engine end).

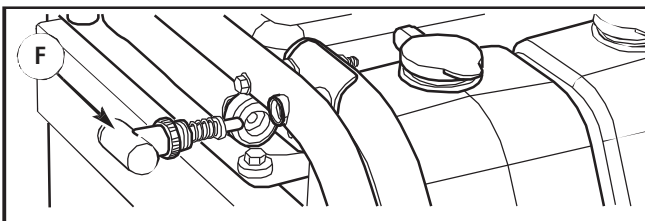

2. Pull handle pin out and lift handle to desired position.

3. Release handle pin and make sure latch (G) locks into place.

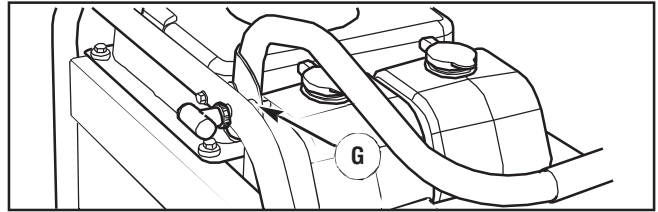

4. Place lock levers on caster wheels in the "Off" position to unlock wheels and move pressure washer to desired location.

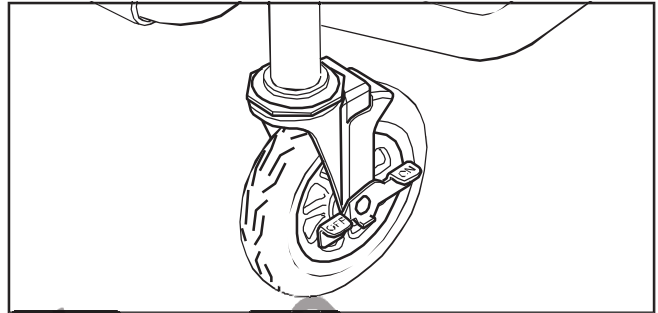

NOTICE Always face pressure washer and push or pull to desired location. When moving pressure washer on an incline, always make sure you are uphill from pressure washer.

5. Place lock levers on caster wheels in the "On" position to lock wheels and keep pressure washer from moving.

Attach Negative Battery Cable

Your unit is equipped with electric start capability but can be started manually. If you choose not to use the electric start feature, you do not need to connect the negative battery cable. The sealed battery on the pressure washer is pre-installed except for the negative (black) battery cable.

⚠ WARNING Battery posts, terminals and related accessories contain lead and lead compounds - chemicals known to the State of California to cause cancer and reproductive harm. Wash hands after handling.

To install:

1. Cut off tie wrap securing loose end of negative (black) cable.
2. Using 8 mm wrenches, remove screw (H) and nut (J) on negative battery terminal (K).

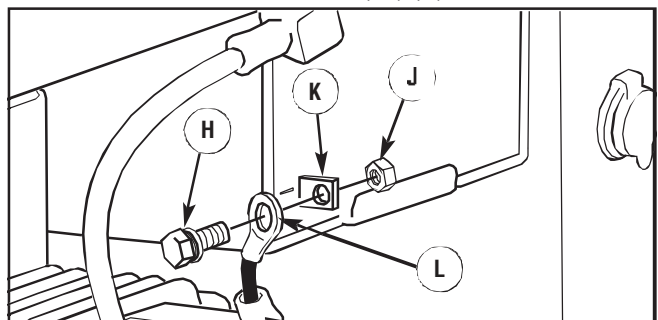

3. Slide negative battery cable (L) over screw.

4. Reattach screw and nut on negative terminal and tighten.
5. Verify that connections to battery and pressure washer are tight and secure.

NOTICE If your battery is discharged, charge prior to use following the instructions in the section *Battery Charger*.

Add Engine Oil

1. Place pressure washer on a flat, level surface.
2. Clean area around oil fill and remove yellow oil fill cap.
3. Using oil funnel, slowly pour contents of provided oil into oil fill opening (A) to the point of overflowing at oil fill cap. DO NOT overfill.

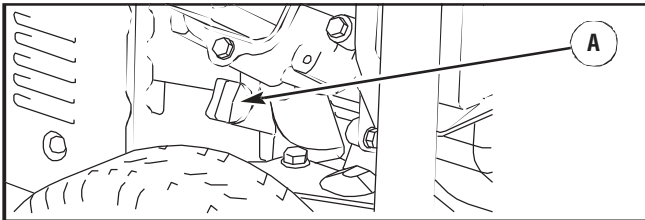

NOTICE Improper treatment of pressure washer could damage it and shorten its life.

- DO NOT attempt to crank or start the engine before it has been properly serviced with the recommended oil. This may result in an engine failure.

4. Replace oil fill cap and fully tighten.

Add Fuel

Fuel must meet these requirements:

- Clean, fresh, unleaded gasoline.
- A minimum of 87 octane/87 AKI (91 RON). For high altitude use, see *High Altitude*.
- Gasoline with up to 10% ethanol (gasohol) or up to 15% MTBE (methyl tertiary butyl ether) is acceptable.

NOTICE Avoid pressure washer damage. Failure to follow Operator's Manual for fuel recommendations voids warranty.

- DO NOT use unapproved gasoline such as E85.
- DO NOT mix oil in gasoline.
- DO NOT modify engine to run on alternate fuels.

WARNING Fuel and its vapors are extremely flammable and explosive which could cause burns, fire or explosion resulting in death, serious injury and/or property damage.



WHEN ADDING FUEL

- Turn pressure washer engine OFF and let it cool at least 2 minutes before removing fuel cap. Loosen cap slowly to relieve pressure in tank.
- Fill fuel tank outdoors.
- DO NOT overfill tank. Allow space for fuel expansion.
- If fuel spills, wait until it evaporates before starting engine.
- Keep fuel away from sparks, open flames, pilot lights, heat, and other ignition sources.
- Check fuel lines, tank, cap and fittings frequently for cracks or leaks. Replace if necessary.
- DO NOT light a cigarette or smoke.

To protect the fuel system from gum formation, mix in a fuel stabilizer when adding fuel. See *Storage*. All fuel is not the same. If you experience starting or performance problems after using fuel, switch to a different fuel provider or change brands. This engine is certified to operate on gasoline. The emission control system for this engine is EM (Engine Modifications).

1. Clean area around fuel fill cap, remove cap.
2. Slowly add unleaded gasoline (B) to fuel tank (C). Be careful not to fill above the baffle (D). This allows adequate space for fuel expansion as shown.

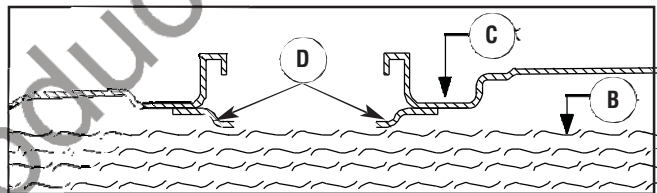

3. Install fuel cap and let any spilled fuel evaporate before starting engine.

High Altitude

At altitudes over 5,000 feet (1524 meters), a minimum 85 octane / 85 AKI (89 RON) gasoline is acceptable. To remain emissions compliant, high altitude adjustment is required. Operation without this adjustment will cause decreased performance, increased fuel consumption, and increased emissions. See an Authorized Briggs & Stratton dealer for high altitude adjustment information. Operation of the engine at altitudes below 2,500 feet (762 meters) with the high altitude kit is not recommended.

Lubricate O-Rings

Lubrication of o-rings is extremely important for installation and operation. The use of a lubricant (petroleum or synthetic grease) during assembly helps seat o-rings properly and provides an improved seal. It also helps protect the o-ring from damage by abrasion, pinching or cutting and extends the life of the o-ring.

NOTICE ALWAYS apply a small amount of lubricant on o-rings prior to assembling the garden hose to the pump inlet (A), high pressure hose to pump outlet (B), high pressure hose (C), nozzle extension (D), and spray gun (E).

Lubricate all connections shown below, following these instructions:

1. Inspect and clean connecting surfaces prior to lubrication and assembly.
2. Use lubricants sparingly during assembly; a light film is all that is required.
3. Use a small brush or cotton swab to apply grease directly to o-rings where they are not accessible (QC fitting, M22 fitting).

Battery Charger

Use battery float charger jack to keep the starting battery charged and ready for use. Battery charging should be done in a dry location, such as inside a garage.

1. Plug charger into unit's "Battery Float Charger" jack, which is located next to the start switch. Plug battery charger into a 120 Volt AC wall receptacle.

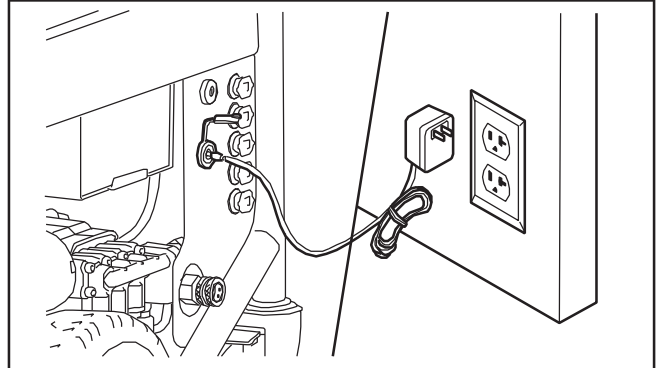

2. Unplug charger from unit and wall outlet when pressure washer is being started and while it is in operation.
3. Keep this charger plugged in when pressure washer is not in use to prolong battery life. The charger has a built in float equalizer and will not overcharge the battery, even when plugged in for an extended period of time.

NOTICE See *Battery Maintenance* for additional information.

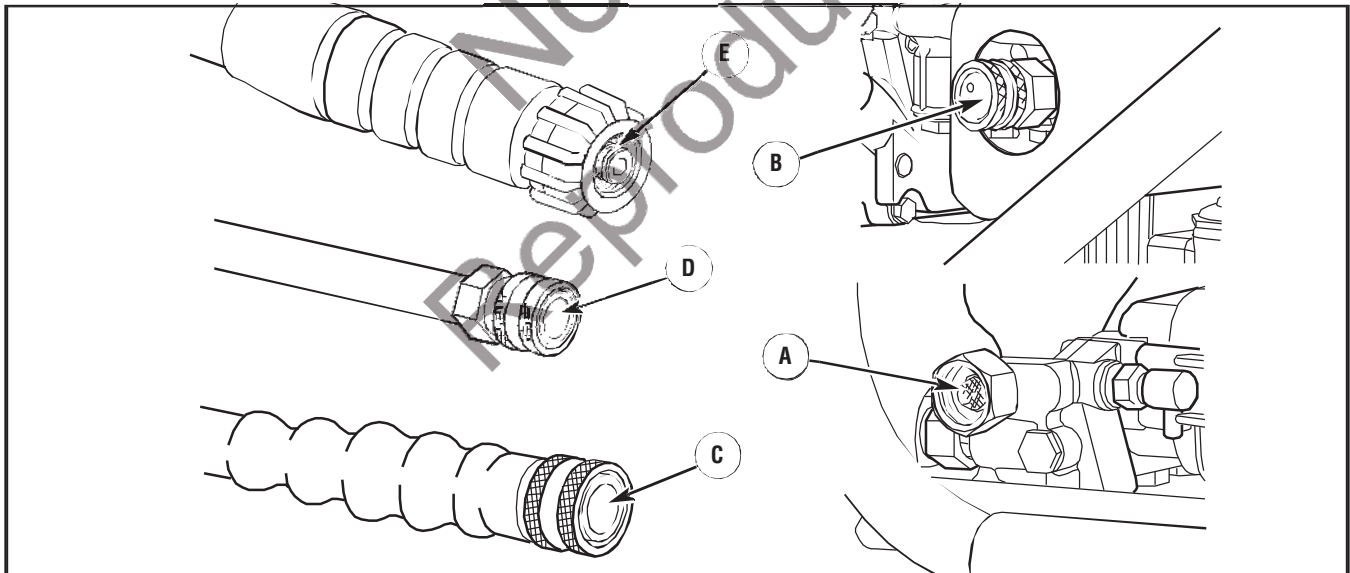

Connect Hose and Water Supply to Pump

NOTICE DO NOT run the pump without the water supply connected and turned on.

- Damage to equipment resulting from failure to follow this instruction will void warranty.

NOTICE Remove and discard the shipping caps from the pump's high pressure outlet and water inlet before attaching hoses.

1. Uncoil high pressure hose and attach quick connect end of hose to base of spray gun. Pull down on collar of quick connect, slide onto spray gun and let go of collar. Tug on hose to be sure of tight connection.

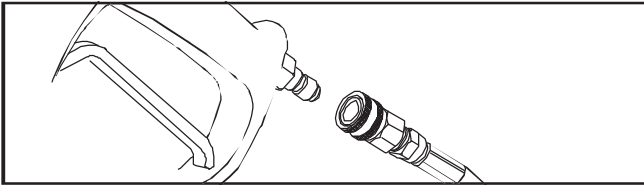

⚠ WARNING The high pressure stream of water that this equipment produces could cut through skin and its underlying tissues, resulting in serious injury and possible amputation.

- NEVER connect high pressure hose to nozzle extension.
- Keep high pressure hose connected to pump and spray gun while system is pressurized.
- Always be certain spray gun, nozzles and accessories are correctly attached.

2. Similarly, attach other end of high pressure hose to high pressure outlet (A) on pump. Pull down on collar of quick connect, slide onto pump and let go of collar. Pull on hose to be sure of tight connection.

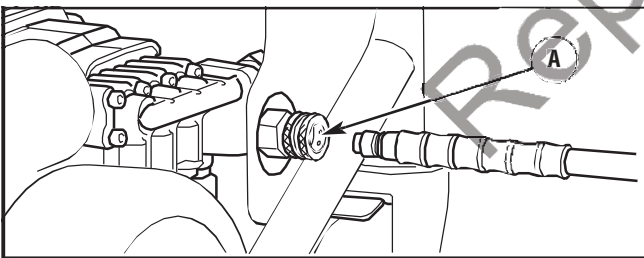

3. Before connecting garden hose to water inlet, inspect inlet screen (B). Clean screen if it contains debris or have it replaced if damaged. DO NOT run pressure washer if inlet screen is damaged.

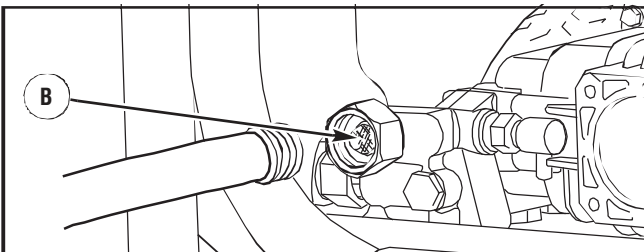

4. Run water through your garden hose for 30 seconds to clean out any debris.

NOTICE DO NOT siphon standing water for the water supply. Use ONLY cold water (less than 100°F).

NOTICE Using a One Way Valve (vacuum breaker or check valve) at pump inlet could cause pump or inlet connector damage.

- There MUST be at least ten feet of unrestricted garden hose between the pressure washer inlet and any device, such as a vacuum breaker or check valve.
- Damage to equipment resulting from failure to follow this instruction will void warranty.

5. Connect the garden hose (not to exceed 50 feet in length) to the water inlet. Tighten by hand.

⚠ WARNING Risk of eye injury.

 Spray could splash back or propel objects resulting in serious injury.

- Always wear indirect vented (chemical splash) safety goggles marked to comply with ANSI Z87.1 when using or in vicinity of this equipment.
- NEVER substitute safety glasses or dry-condition goggles for indirect vented safety goggles.

6. Turn ON the water, press red button (C) on the gun and squeeze the trigger to purge the pump system of air and impurities.

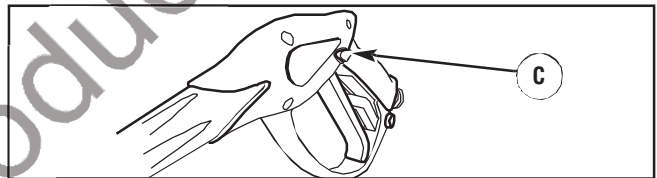

Checklist Before Starting Engine

Review the unit's assembly to ensure you have performed all of the following.

1. Be sure to read *Operator Safety* and *Operation* sections before using pressure washer.
2. Make sure handle is in place and secure.
3. Check that oil has been added to proper level in the engine crankcase.
4. Add proper fuel to fuel tank.
5. Check for properly tightened hose connections.
6. Check to make sure there are no kinks, cuts, or damage to high pressure hose.
7. Provide a proper water supply at an adequate flow.

Features and Controls



Read this Operator's Manual and safety rules before operating your pressure washer.

Compare the illustrations with your pressure washer, to familiarize yourself with the locations of various controls and adjustments. Save this manual for future reference.

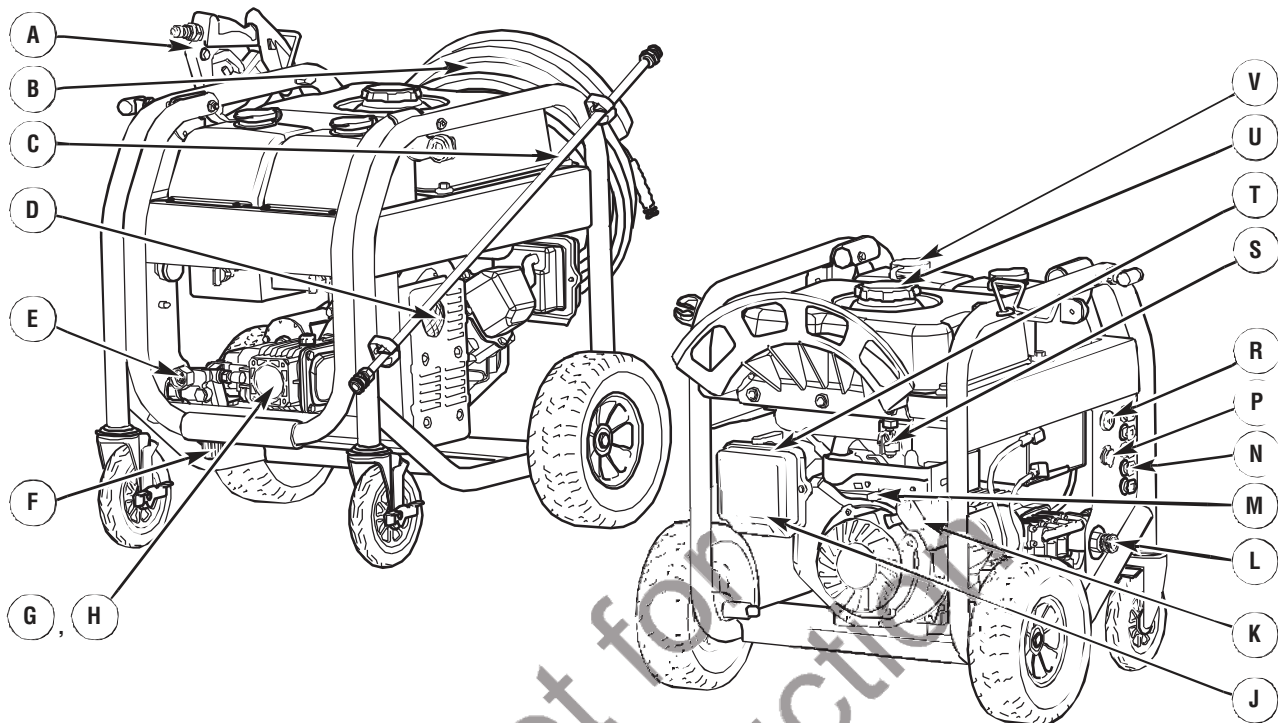

A - Spray Gun — Controls the application of water onto cleaning surface with trigger device. Includes trigger lock.

B - High Pressure Hose — Connect one end to water pump and the other end to spray gun.

C - Nozzle Extension with Quick Connect — Allows you to switch between five different spray tips.

D - Spark Arrester Muffler — Exhaust muffler lowers engine noise and is equipped with a spark arrester screen.

E - Water Inlet — Connection for garden hose.

F - Pressure Control Knob — Varies pressure of high pressure spray.

G - Pump — Develops high pressure.

H - Automatic Cool Down System — Cycles water through pump when water reaches 125°-155°F. Warm water will discharge from pump onto ground. This system prevents internal pump damage.

J - Air Filter — Protects engine by filtering dust and debris out of intake air.

K - Recoil Starter — Used for starting the engine manually.

L - High Pressure Outlet — Connection for high pressure hose.

M - Throttle Lever — Sets engine in starting mode for electric or manual starting and stops a running engine.

N - Quick Connect Spray Tips — Detergent, 0°, 15°, 25° and 40°; for various high pressure cleaning applications.

P - Battery Float Charger Jack — Use battery float charger jack to keep the starting battery charged and ready for use.

R - Start Switch — Turn key to start (Ⓚ) position to start the engine.

S - Fuel Valve — Used to turn fuel supply on and off to engine.

T - Choke Lever — Prepares a cold engine for starting.

U - Fuel Tank — Fill tank with regular unleaded fuel. Always leave room for fuel expansion.

V - Cleaning Tanks — Use to hold up to one gallon (3.8 l) of pressure washer safe detergent in each tank.

Items Not Shown:

Identification Label — Provides model and serial number of pressure washer. Please have these readily available if calling for assistance.

Oil Drain — Drain engine oil here.

Oil Fill — Check and add engine oil here.

Operation

If you have any problems operating your pressure washer, please call the pressure washer helpline at **(800) 743-4115**.

Pressure Washer Location

Carbon Monoxide Poisoning

⚠ WARNING POISONOUS GAS HAZARD. Engine exhaust contains carbon monoxide, a poisonous gas that could kill you in minutes. You **CANNOT** smell it, see it, or taste it. Even if you do not smell exhaust fumes, you could still be exposed to carbon monoxide gas.

- Operate this product **ONLY** outside far away from windows, doors and vents to reduce the risk of carbon monoxide gas from accumulating and potentially being drawn towards occupied spaces.
- Install battery-operated carbon monoxide alarms or plug-in carbon monoxide alarms with battery back-up according to the manufacturer's instructions. Smoke alarms cannot detect carbon monoxide gas.
- **DO NOT** run this product inside homes, garages, basements, crawlspaces, sheds, or other partially-enclosed spaces even if using fans or opening doors and windows for ventilation. Carbon monoxide can quickly build up in these spaces and can linger for hours, even after this product has shut off.
- **ALWAYS** place this product downwind and point the engine exhaust away from occupied spaces.

If you start to feel sick, dizzy, or weak while using this product, shut it off and get to fresh air **RIGHT AWAY**. See a doctor. You may have carbon monoxide poisoning.

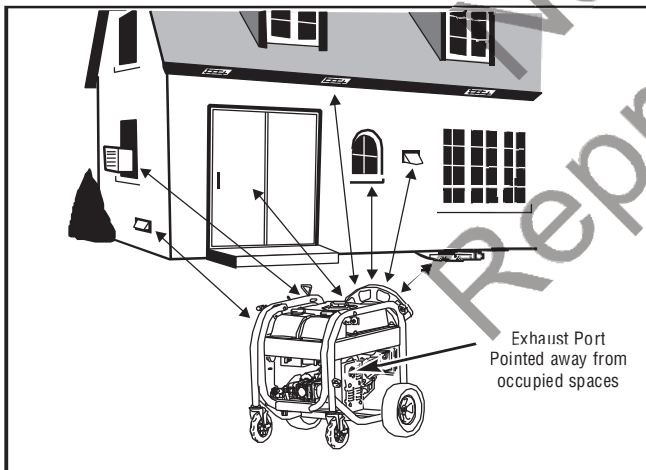

Risk of Fire Clearances

⚠ WARNING Exhaust heat/gases could ignite combustibles, structures or damage fuel tank causing a fire, resulting in death, serious injury and/or property damage.

- Keep at least 5 ft. (1.5 m) clearance on all sides of pressure washer including overhead.

How to Start Your Pressure Washer

To start your pressure washer for the first time, follow these instructions step-by-step. This starting information also applies if you have let the pressure washer sit idle for at least a day.

1. Place pressure washer near an outside water source capable of supplying water at a flow rate greater than 4.2 gallons per minute and no less than 20 PSI at pressure washer end of garden hose. **DO NOT** siphon supply water.
2. Check that high pressure hose is tightly connected to spray gun and pump. See *Assembly* section.
3. Make sure unit is in a level position.
4. Connect garden hose to water inlet on pressure washer pump.

NOTICE **DO NOT** run the pump without the water supply connected and turned on.

- Damage to equipment resulting from failure to follow this instruction will void warranty.
5. Turn **ON** water, point gun in a safe direction, press red button and squeeze trigger to purge pump system of air and impurities.
 6. Attach nozzle extension to spray gun. Tighten by hand.

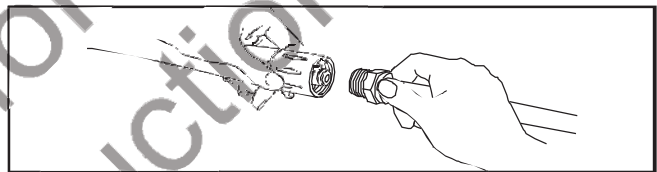

7. Choose spray tip you want to use, pull back on collar of nozzle extension, insert spray tip and release collar. Tug on spray tip to make sure it is securely in place. See *How to Use Spray Tips*.

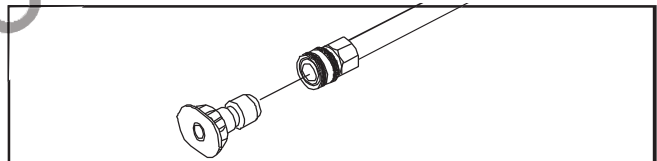

8. Turn fuel valve **(A)** to "**On**" position. The fuel valve handle should be vertical (pointing toward the ground) for fuel to flow.

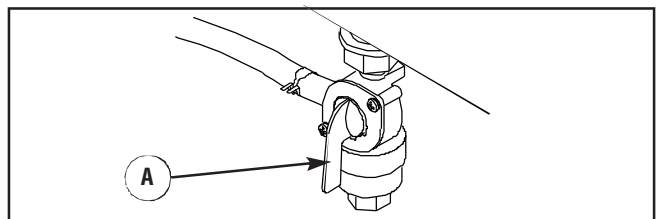

9. Move throttle control lever **(B)** to "**Fast**" position, shown on engine as a rabbit 🐰.

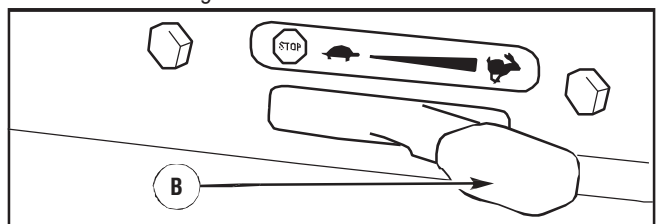

10. Move choke lever (A) to “Choke” | \ | position.

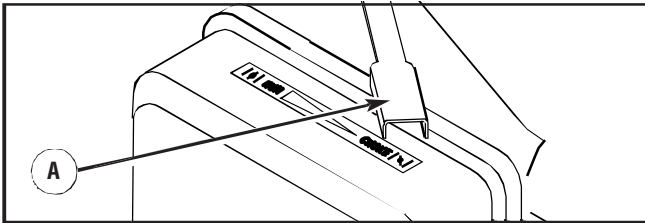

NOTICE For a warm engine, be sure the choke lever is in the “Run” | \ | position.

NOTICE Before starting the pressure washer, be sure you are wearing safety goggles as described below.

WARNING Risk of eye injury.
Spray could splash back or propel objects resulting in serious injury.

- Always wear indirect vented (chemical splash) safety goggles marked to comply with ANSI Z87.1 when using or in vicinity of this equipment.
- NEVER substitute safety glasses or dry-condition goggles for indirect vented safety goggles.

11A. **For electric starting**, turn and hold key in start switch to start (Ⓢ) position until pressure washer starts. To prolong the life of starter components, DO NOT hold key in start (Ⓢ) position for more than 5 seconds, and pause for at least 1 minute between starting attempts.

- If engine starts, proceed to step 14.
- If engine fails to start, proceed to step 12.

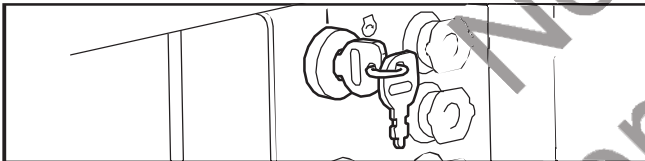

NOTICE If battery is discharged, use manual starting instructions.

11B. **For manual starting**, position yourself as recommended below, grasp recoil handle and pull slowly until you feel some resistance. Then pull rapidly to start engine. Return starter grip handle slowly. DO NOT let rope “snap back” against starter.

- If engine starts, proceed to step 14.
- If engine fails to start, proceed to step 12.



WARNING Starter cord kickback (rapid retraction) will pull hand and arm toward engine faster than you can let go which could cause broken bones, fractures, bruises, or sprains resulting in serious injury.

- NEVER pull starter cord without first relieving spray gun pressure.
- When starting engine, pull cord slowly until resistance is felt and then pull rapidly to avoid kickback.
- After each starting attempt, where engine fails to run, always point spray gun in safe direction, press red button and squeeze spray gun trigger to release high pressure.
- Firmly grasp spray gun with both hands when using high pressure spray to avoid injury when spray gun kicks back.

NOTICE After each starting attempt, where engine fails to run, always point gun in safe direction, press red button and squeeze spray gun trigger to release high pressure.

12. Move choke lever half way, pull recoil handle twice or turn and hold key in start switch to start (Ⓢ) position as described in step 11A.
 - If engine fails to start, repeat steps 10 thru 11.
13. If engine fails to start after six pulls, move choke lever to “Run” | \ | position, and repeat step 11.
14. When engine starts, slowly move choke lever to “Run” | \ | position, as engine warms. If engine falters, move choke lever to “Choke” | \ | position, then to “Run” | \ | position.

NOTICE Always keep the throttle control lever in the “Fast” Ⓢ position when operating the pressure washer.

WARNING The high pressure stream of water that this equipment produces could cut through skin and its underlying tissues, resulting in serious injury and possible amputation.

Spray gun traps high water pressure, even when engine is stopped and water is disconnected, which could result in serious injury.

- DO NOT allow CHILDREN to operate pressure washer.
- Keep high pressure hose connected to pump and spray gun while system is pressurized.
- NEVER aim spray gun at people, animals, or plants.
- DO NOT secure spray gun in open position.
- DO NOT leave spray gun unattended while machine is running.
- NEVER use a spray gun which does not have a trigger lock or trigger guard in place and in working order.
- Always be certain spray gun, nozzles and accessories are correctly attached.

WARNING Exhaust heat/gases could ignite combustibles, structures or damage fuel tank causing a fire, resulting in death, serious injury and/or property damage. Contact with muffler area could cause burns resulting in serious injury.



- DO NOT touch hot parts and AVOID hot exhaust gases.
 - Allow equipment to cool before touching.
 - Keep at least 5 feet (1.5 m) of clearance on all sides of pressure washer including overhead.
 - It is a violation of California Public Resource Code, Section 4442, to use or operate the engine on any forest-covered, brush-covered, or grass-covered land unless the exhaust system is equipped with a spark arrester, as defined in Section 4442, maintained in effective working order. Other states or federal jurisdictions may have similar laws.
- Contact the original equipment manufacturer, retailer, or dealer to obtain a spark arrester designed for the exhaust system installed on this engine.
- Replacement parts must be the same and installed in the same position as the original parts.

How to Stop Your Pressure Washer

1. Release spray gun trigger and let engine idle for two minutes.
2. Move throttle control lever on engine to “**Stop**”  position.
3. Turn fuel valve to “**Off**” position.
4. ALWAYS point spray gun in a safe direction, press red button and squeeze spray gun trigger to release retained high water pressure.

WARNING The high pressure stream of water that this equipment produces could cut through skin and its underlying tissues, resulting in serious injury and possible amputation. Spray gun traps high water pressure, even when engine is stopped and water is disconnected, which could result in serious injury.



- Keep high pressure hose connected to pump and spray gun while system is pressurized.
- ALWAYS point spray gun in safe direction, press red button and squeeze spray gun trigger to release high pressure, every time you stop engine.

How to Store Accessories

The unit is equipped with multiple places to store your spray gun, nozzle extension, high pressure hose and spray tips.

1. Place spray gun into spray gun holder wireform as shown.

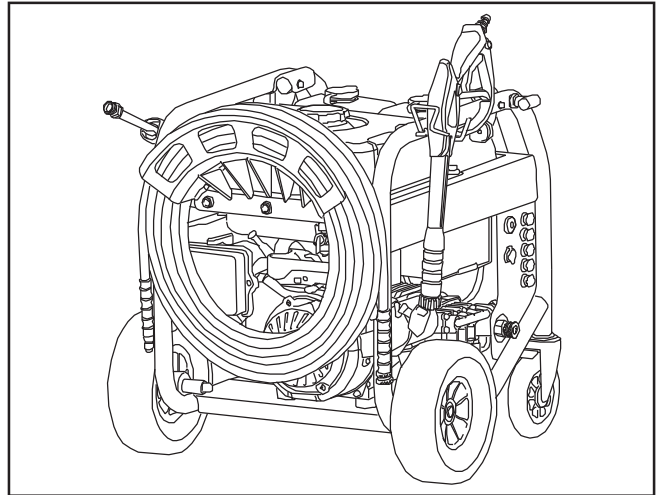

2. Place nozzle extension into metal spring clips on side of unit as shown.
3. Coil high pressure hose onto hose wrap.
4. Insert multi-colored spray tips in spaces provided on side panel.

How to Use Spray Tips

The quick-connect on the nozzle extension allows you to switch between five different quick connect spray tips. Spray tips can be changed while pressure washer is running once spray gun trigger lock is engaged. The spray tips vary the spray pattern as shown.

Follow these instructions to change spray tips:

1. Pull back collar on quick-connect and pull current spray tip off. Store spray tips in holder provided on the side panel.

WARNING The high pressure stream of water that this equipment produces could cut through skin and its underlying tissues, resulting in serious injury and possible amputation.



- NEVER exchange spray tips without the trigger lock being engaged on the spray gun.
- DO NOT twist spray tips while spraying.

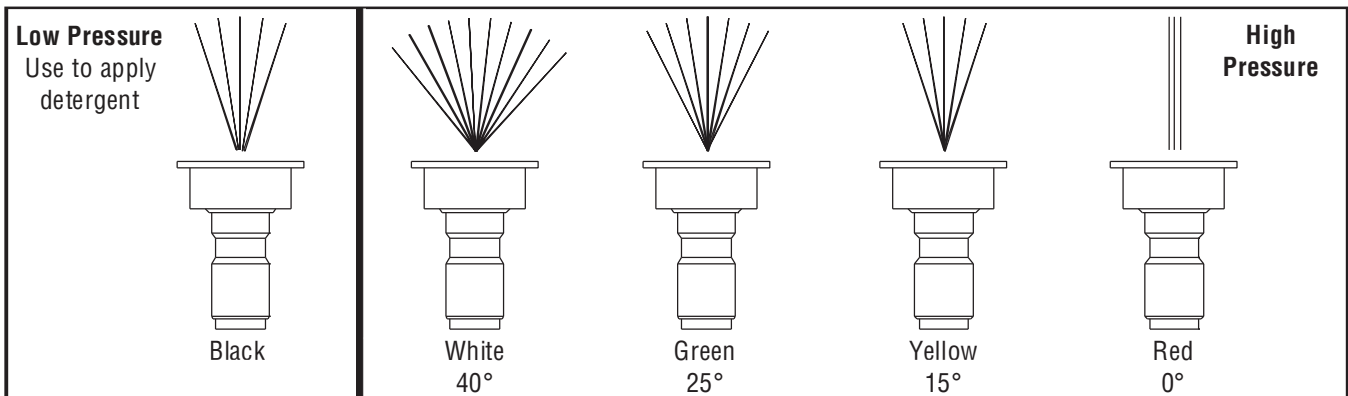

2. Select desired spray tip:
 - For gentle rinse, select white 40° or green 25° spray tip.
 - To scour surface, select yellow 15° or red 0° spray tip.
 - To apply detergent, select black spray tip.
3. Pull back on collar, insert new spray tip and release collar. Tug on spray tip to make sure it is securely in place.

Usage Tips

- For most effective cleaning, keep spray tip from 8 to 24 inches away from cleaning surface.
- If you get spray tip too close, especially using a high pressure spray tip, you may damage surface being cleaned.
- DO NOT get closer than 6 inches when cleaning tires.

Applying Detergent

⚠ WARNING Chemical Burn Hazard. Chemicals could cause burns resulting in death, serious injury, and/or property damage.

- DO NOT use caustic liquid with pressure washer.
- Use ONLY pressure washer safe detergents/soaps. Follow all manufacturers instructions.

To apply detergent, follow these steps:

1. Review use of spray tips.
2. Prepare detergent solution as required by job.
3. Make sure detergent shut-off valves on cleaning tanks are in "Off" position.
4. Pour detergent solution into one of the cleaning tanks.

NOTICE Each cleaning tank holds up to one gallon (3.8 l).

5. Fill other cleaning tank with a different prepared solution, as desired.
6. Make sure black detergent spray tip is installed.

NOTICE Detergent cannot be applied with the high pressure spray tips (White, Green, Yellow or Red).

7. Make sure garden hose is connected to water inlet. Check that high pressure hose is connected to spray gun and pump. Turn on water.

NOTICE You must attach all hoses before you start engine.

- Starting the engine without all the hoses connected and without the water turned ON could damage the pump.
 - Damage to equipment resulting from failure to follow this instruction will void warranty.
8. Start engine following instructions *How to Start Your Pressure Washer*.
 9. Rotate detergent shut-off valve on desired cleaning tank to "On" position.

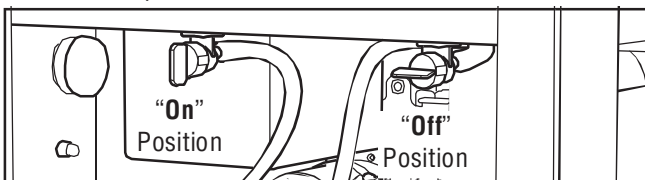

⚠ CAUTION Mixing detergents can result in bodily injury and/or property damage.

- DO NOT open both detergent shut-off valves at the same time.

10. Apply detergent to a dry surface, starting at lower portion of area to be washed and work upward, using long, even, overlapping strokes.
11. Allow detergent to "soak in" for 3-5 minutes before washing and rinsing. Reapply as needed to prevent surface from drying. DO NOT allow detergent to dry on (prevents streaking).

Pressure Washer Rinsing

For Rinsing:

1. Turn detergent shut-off valves to "Off" position.
2. Remove black detergent spray tip from nozzle extension.
3. Select and install desired high pressure spray tip following instructions *How to Use Spray Tips*.
4. Keep the spray gun a safe distance from the area you plan to spray.

⚠ WARNING Kickback from spray gun could cause you to fall resulting in death or serious injury.



- Operate pressure washer from a stable surface.
- Be extremely careful if you must use the pressure washer from a ladder, scaffolding, or any other similar location.
- Firmly grasp spray gun with both hands when using high pressure spray to avoid injury when spray gun kicks back.

5. Increase (decrease) spray pressure by turning pressure control knob (A) counterclockwise (clockwise). Use lower pressure to wash items such as a car or boat. Use higher pressure to strip paint and degrease driveways.

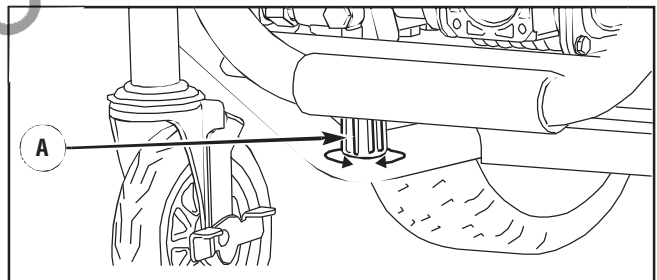

6. Apply a high pressure spray to a small area and then check surface for damage. If no damage is found, you can assume it is okay to continue rinsing.
7. Start at top of area to be rinsed, working down with same overlapping strokes as you used for cleaning.

Automatic Cool Down System (Thermal Relief)

If you run the engine on your pressure washer for 3-5 minutes without pressing the trigger on the spray gun, circulating water in the pump can reach temperatures above 125°F (51°C). The system engages to cool the pump by discharging the warm water onto the ground.

Maintenance

Maintenance Schedule

Follow the hourly or calendar intervals, whichever occurs first. More frequent service is required when operating in adverse conditions noted below.

First 5 Hours
<ul style="list-style-type: none">• Change engine oil
Every 8 Hours or Daily
<ul style="list-style-type: none">• Check/clean water inlet screen¹• Check high pressure hose• Check detergent siphoning tube/tank• Check spray gun and assembly for leaks• Clean debris• Check engine oil level
Every 25 Hours or Yearly
<ul style="list-style-type: none">• Service engine air cleaner²
Every 50 Hours or Yearly
<ul style="list-style-type: none">• Change engine oil²
Every 100 Hours or Yearly
<ul style="list-style-type: none">• Service spark plug• Inspect muffler and spark arrester• Clean cooling system²
Every 200 Hours or 3 Months
<ul style="list-style-type: none">• Change pump oil³

¹ Clean if clogged. Replace if perforated or torn.

² Service more often under dirty or dusty conditions.

³ Change pump oil after the first (50) operating hours and then every 200 hours or 3 months thereafter.

General Recommendations

Regular maintenance will improve the performance and extend the life of the pressure washer. See any qualified dealer for service.

The pressure washer's warranty does not cover items that have been subjected to operator abuse or negligence. To receive full value from the warranty, the operator must maintain the pressure washer as instructed in this manual, including proper storage as detailed in *Winter Storage* and *Long Term Storage*.

NOTICE Should you have questions about replacing components on your pressure washer, please call **(800) 743-4115** for assistance.

Some adjustments will need to be made periodically to properly maintain your pressure washer.

All service and adjustments should be made at least once each season. Follow the requirements in the Maintenance Schedule chart above.

NOTICE Once a year you should clean or replace the spark plug, clean or replace the air filter, and check the spray gun and nozzle extension assembly for wear. A new spark plug and clean air filter assure proper fuel-air mixture and help your engine run better and last longer.

Emissions Control

Maintenance, replacement, or repair of the emissions control devices and systems may be performed by any non-road engine repair establishment or individual.

However, to obtain "no charge" emissions control service, the work must be performed by a factory authorized dealer. See the *Emissions Warranty*.

Before Each Use

1. Check engine oil level.
2. Clean debris.
3. Check water inlet screen for damage.
4. Check high pressure hose for leaks.
5. Check detergent siphoning tubes and tank for damage.
6. Check spray gun and nozzle extension for leaks.
7. Rinse out garden hose to flush out debris.

Battery Maintenance

Other than float charging, described elsewhere, no maintenance is required for the starting battery. Keep the battery and terminals clean and dry.

NOTICE Battery charging should be performed in a dry location, such as inside a garage.

▲ WARNING Battery posts, terminals and related accessories contain lead and lead compounds - chemicals known to the State of California to cause cancer and reproductive harm. Wash hands after handling.

Fuel Valve Maintenance

The fuel valve is equipped with a fuel sediment cup, screen, and o-ring that need to be cleaned.

1. Move fuel valve to "Off" position.
2. Remove sediment cup (A) from fuel valve. Remove o-ring (B) and screen (C) from fuel valve.

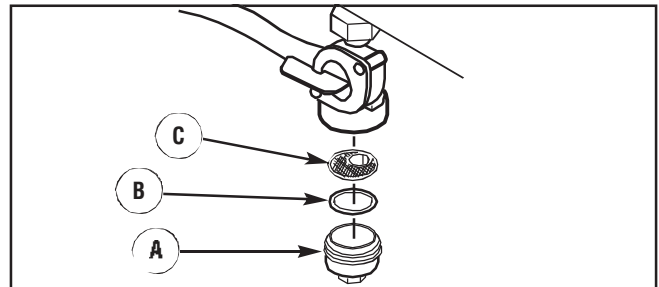

3. Wash sediment cup, o-ring, and screen in a nonflammable solvent. Dry them thoroughly.

- Place screen and o-ring into fuel valve. Install sediment cup and tighten securely.
- Move fuel valve to “On” position, and check for leaks. Replace fuel valve if there is any leakage.

Pressure Washer Maintenance

Clean Debris

Daily or before use, clean accumulated debris from pressure washer. Keep linkage, spring and controls clean. Keep area around and behind muffler free from any combustible debris. Inspect cooling air slots and openings on the pressure washer. These openings must be kept clean and unobstructed.

Pressure washer parts should be kept clean to reduce the risk of overheating and ignition of accumulated debris.

- Use a damp cloth to wipe exterior surfaces clean.

NOTICE Improper treatment of pressure washer could damage it and shorten its life.

- DO NOT insert any objects through cooling slots.
- Use a soft bristle brush to loosen caked on dirt, oil, etc.
- Use a vacuum cleaner to pick up loose dirt and debris.

Check and Clean Inlet Screen

Examine the screen on the pump’s water inlet. Clean it if the screen is clogged or replace it if screen is damaged.

Check High Pressure Hose

The high pressure hose can develop leaks from wear, kinking, or abuse. Inspect the hose each time before using them. Check for cuts, leaks, abrasions or bulging of cover, damage or movement of couplings. If any of these conditions exist, replace the hose immediately.

-  **WARNING** The high pressure stream of water that this equipment produces could cut through skin and its underlying tissues, resulting in serious injury and possible amputation.
- NEVER repair high pressure hose. Replace it.
 - Replacement hose rating MUST equal or exceed maximum pressure rating of unit.

Check Detergent Siphoning Tube

Examine the detergent tanks and detergent siphoning tubes and clean if clogged. The tubes should fit tightly on the barbed fitting of the pump and detergent shut-off valves. Examine the tubes for leaks or tears. Replace the tanks or tubes if either is damaged.

Detergent Siphoning Check Ball

Occasionally check ball in detergent siphoning system may become stuck from storage, dried soap, or minerals in water. The check ball can be freed by performing the following:

NOTICE Before performing this procedure, be sure you are wearing safety goggles as described below.

-  **WARNING** Risk of eye injury. Spray could splash back or propel objects resulting in serious injury.
- Always wear indirect vented (chemical splash) safety goggles marked to comply with ANSI Z87.1 when using or in vicinity of this equipment.
 - NEVER substitute safety glasses or dry-condition goggles for indirect vented safety goggles.

- Shut off engine and turn off water supply.
- ALWAYS point spray gun in a safe direction, press red button and squeeze spray gun trigger to release retained high water pressure.

-  **WARNING** The high pressure stream of water that this equipment produces could cut through skin and its underlying tissues, resulting in serious injury and possible amputation. Spray gun traps high water pressure, even when engine is stopped and water is disconnected, which could result in serious injury.
- Keep high pressure hose connected to pump and spray gun while system is pressurized.
 - ALWAYS point spray gun in safe direction, press red button and squeeze spray gun trigger to release high pressure, every time you stop engine.

- Remove detergent siphoning hose from barbed fitting on pump.
- Using a firm, blunt object 7/64” in diameter or smaller, by at least 1” long, such as an Allen wrench, slowly insert the object into the barbed fitting until you meet resistance. This resistance is the check ball.
- Slowly push down until you feel the ball move slightly, push no more than 1/8”. Slight pressure may be required to free the ball.
- Repeat steps 4 and 5 if necessary.
- Reinstall detergent siphoning hose onto barb fitting.
- Treat with PumpSaver as described in *Protecting the Pump* during storage to prevent reoccurrence.

Check Spray Gun

Examine the hose connection to the spray gun and make sure it is secure. Test the trigger by pressing the red button and making sure the trigger “springs back” into place when you release it. You should not be able to press the trigger without pressing the red button. Replace spray gun immediately if it fails any of these tests.

Spray Tip Maintenance

A pulsing sensation felt while squeezing the spray gun trigger may be caused by excessive pump pressure. The principal cause of excessive pump pressure is a spray tip clogged or restricted with foreign materials, such as dirt, etc. To correct the problem, immediately clean the spray tip following these instructions:

1. Shut off engine and turn off water supply.
2. ALWAYS point spray gun in a safe direction, press red button and squeeze spray gun trigger to release retained high water pressure.

⚠ WARNING The high pressure stream of water that this equipment produces could cut through skin and its underlying tissues, resulting in serious injury and possible amputation.



Spray gun traps high water pressure, even when engine is stopped and water is disconnected, which could result in serious injury.

- Keep high pressure hose connected to pump and spray gun while system is pressurized.
- ALWAYS point spray gun in safe direction, press red button and squeeze spray gun trigger to release high pressure, every time you stop engine.

3. Remove spray tip from end of nozzle extension.
4. Use a small paper clip to free any foreign material clogging or restricting spray tip (A).

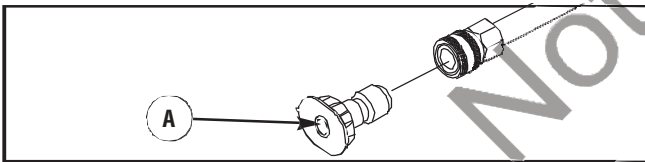

5. Remove nozzle extension from spray gun.
6. Using a garden hose, remove additional debris by back flushing water through nozzle extension. Back flush between 30 to 60 seconds.

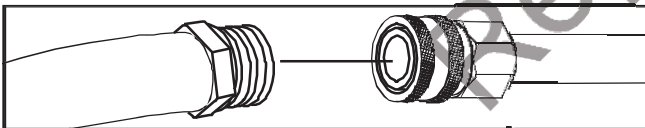

7. Reinstall spray tip into nozzle extension.
8. Reconnect nozzle extension to spray gun.
9. Make sure garden hose is connected to water inlet. Check that high pressure hose is connected to spray gun and pump. Turn on water.
10. Start engine following instructions *How to Start Your Pressure Washer*.
11. Test pressure washer by operating with each quick connect spray tip.

O-Ring Maintenance

Purchase an O-Ring/Maintenance Kit, model 196002GS, by contacting the nearest authorized service center. It is not included with the pressure washer. This kit includes replacement o-rings, rubber washer and water inlet filter. Refer to the instruction sheet provided in the kit to service your unit's o-rings.

⚠ WARNING The high pressure stream of water that this equipment produces could cut through skin and its underlying tissues, resulting in serious injury and possible amputation.



- NEVER repair leaking connections with sealant of any kind. Replace o-ring or seal.

Pump Oil Maintenance

Changing Pump Oil

NOTICE When changing pump oil, use only high quality SAE 30 weight oil. Use no special additives.

Change pump oil as follows:

1. Clean area around brass oil drain plug at bottom of pump.
2. Remove oil drain plug. Drain oil completely into an approved container.
3. When oil has completely drained, install oil drain plug and tighten firmly.
4. Clean area around pump oil dipstick. Remove dipstick and fill pump with recommended oil (approximately 12 oz. (355 ml)) to "Full" mark on dipstick.
5. Install pump oil dipstick.
6. Wipe up any spilled oil.

Engine Maintenance

⚠ WARNING Unintentional sparking could cause fire or electric shock resulting in death or serious injury.



WHEN ADJUSTING OR MAKING REPAIRS TO YOUR PRESSURE WASHER

- Disconnect the spark plug wire from the spark plug and place the wire where it cannot contact spark plug.

WHEN TESTING FOR ENGINE SPARK

- Use approved spark plug tester.
- DO NOT check for spark with spark plug removed.

Oil

Oil Recommendations

We recommend the use of Briggs & Stratton Warranty Certified oils for best performance. Other high-quality detergent oils are acceptable if classified for service SF, SG, SH, SJ or higher. DO NOT use special additives.

Outdoor temperatures determine the proper oil viscosity for the engine. Use the chart to select the best viscosity for the outdoor temperature range expected.

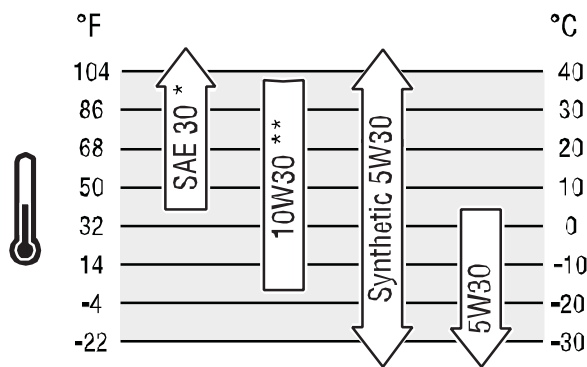

* Below 40°F (4°C) the use of SAE 30 will result in hard starting.

** Above 80°F (27°C) the use of 10W30 may cause increased oil consumption. Check oil level more frequently.

Checking Oil Level

Oil level should be checked prior to each use or at least every 8 hours of operation. Keep oil level maintained.

1. Make sure pressure washer is on a level surface.
2. Clean area around oil fill and remove oil fill cap.
3. Verify oil is at the point of overflowing at oil fill opening.
4. Replace and tighten oil fill cap.

Adding Engine Oil

1. Make sure pressure washer is on a level surface.
2. Check oil level as described in *Checking Oil Level*.
3. If needed, slowly pour oil into oil fill opening to the point of overflowing at oil fill.
4. Replace and tighten oil fill cap.

Changing Engine Oil

If you are using your pressure washer under extremely dirty or dusty conditions, or in extremely hot weather, change the oil more often.

CAUTION Avoid prolonged or repeated skin contact with used motor oil.

- Used motor oil has been shown to cause skin cancer in certain laboratory animals.
- Thoroughly wash exposed areas with soap and water.



KEEP OUT OF REACH OF CHILDREN. DON'T POLLUTE. CONSERVE RESOURCES. RETURN USED OIL TO COLLECTION CENTERS.

Change engine oil when engine is cold, as follows:

1. Make sure unit is on a level surface.
2. Disconnect the spark plug wire from the spark plug and place the wire where it cannot contact spark plug.
3. Clean area around oil drain plug (A). The oil drain plug is located at base of engine.

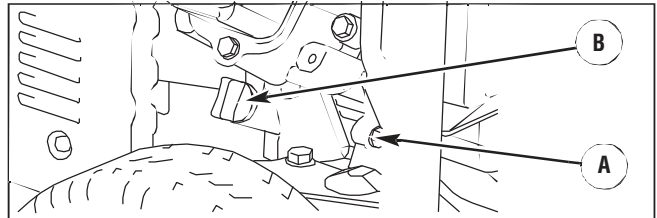

4. Remove oil drain plug and drain oil completely into a suitable container.
5. Reinstall oil drain plug and tighten securely. Remove oil fill cap.
6. Using oil funnel, slowly pour oil (about 20 oz.) into oil fill opening (B) to the point of overflowing at oil fill cap. DO NOT overfill.
7. Reinstall oil fill cap. Finger tighten cap securely.
8. Wipe up any spilled oil.
9. Reconnect spark plug wire to spark plug.

Service Air Cleaner

Your engine will not run properly and may be damaged if you run it with a dirty air cleaner. Replace more often if operating under dirty or dusty conditions.

To service the air cleaner, follow these steps:

1. Loosen screws (C) and remove air cleaner cover (D).

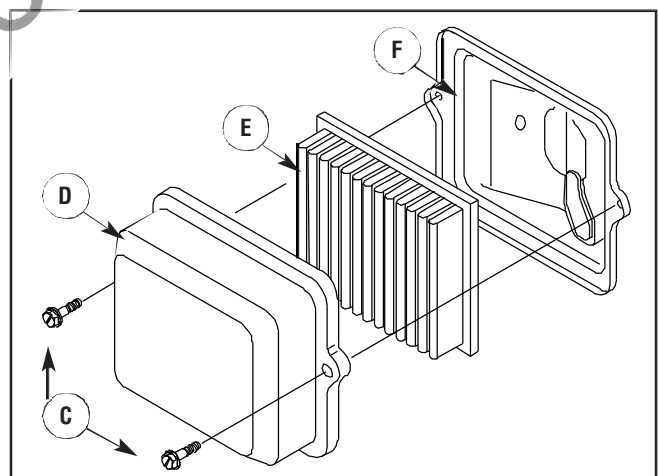

2. Carefully remove cartridge (E) from base (F).
3. Install clean (or new) air cleaner assembly inside cover. Dispose of old filter properly.
4. Assemble air cleaner cover onto base and tighten screws.

Service Spark Plug

Changing the spark plug will help your engine to start easier and run better.

1. Clean area around spark plug.
2. Remove and inspect spark plug.
3. Replace spark plug if electrodes are pitted, burned or porcelain is cracked. Use the recommended replacement plug. See *Specifications*.
4. Check electrode gap with wire feeler gauge and reset spark plug gap to recommended gap if necessary (see *Specifications*).

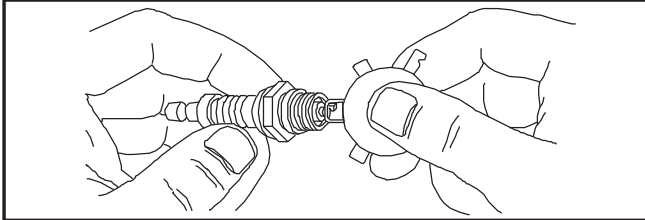

5. Install spark plug and tighten firmly.

Inspect Muffler and Spark Arrester

Inspect the muffler for cracks, corrosion, or other damage. Remove the spark arrester, if equipped, and inspect for damage or carbon blockage. If replacement parts are required, make sure to use only original equipment replacement parts.

WARNING Exhaust heat/gases could ignite combustibles, structures or damage fuel tank causing a fire, resulting in death, serious injury and/or property damage.

Contact with muffler area could cause burns resulting in serious injury.

- DO NOT touch hot parts and AVOID hot exhaust gases.
- Allow equipment to cool before touching.
- Keep at least 5 feet (1.5 m) of clearance on all sides of pressure washer including overhead.
- It is a violation of California Public Resource Code, Section 4442, to use or operate the engine on any forest-covered, brush-covered, or grass-covered land unless the exhaust system is equipped with a spark arrester, as defined in Section 4442, maintained in effective working order. Other states or federal jurisdictions may have similar laws.

Contact the original equipment manufacturer, retailer, or dealer to obtain a spark arrester designed for the exhaust system installed on this engine.

- Replacement parts must be the same and installed in the same position as the original parts.

Clean and inspect the spark arrester as follows:

1. To remove muffler heat shield (A) from muffler (B), remove four screws that connect guard to muffler bracket.

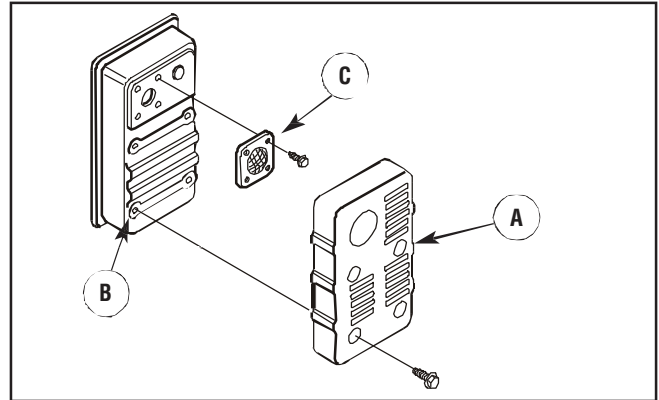

2. Remove four screws that attach spark arrester screen (C).
3. Inspect screen and obtain a replacement if torn, perforated or otherwise damaged. DO NOT use a defective screen. If screen is not damaged, clean it with commercial solvent.
4. Reattach screen and muffler guard.

Air Cooling System

Over time debris may accumulate in cylinder cooling fins and cannot be observed without partial engine disassembly. For this reason, we recommend you have a qualified service dealer clean the cooling system per recommended intervals (see *Maintenance Schedule* in beginning of *Maintenance* section). Equally important is to keep top of engine free from debris. See *Clean Debris*.

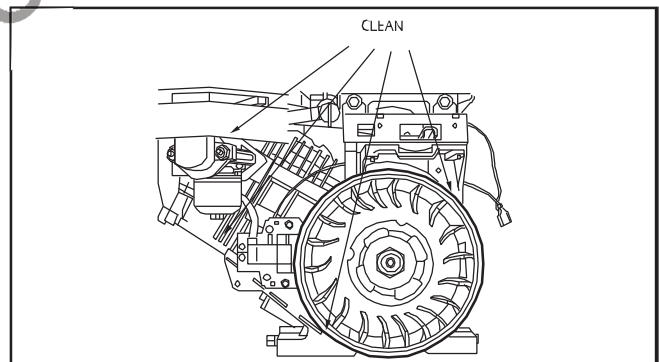

Carburetor Adjustment

The carburetor on this engine is low emission. It is equipped with a non-adjustable idle mixture valve. Top speed has been set at the factory. If adjustment is required, see an authorized service dealer.

- CAUTION** Excessively high operating speeds could result in minor injury and/or pressure washer damage. Excessively low speeds impose a heavy load.
- DO NOT tamper with governor spring, links or other parts to increase engine speed. Pressure washer supplies correct rated pressure and flow when running at governed speed.
 - DO NOT modify pressure washer in any way.

After Each Use

Water should not remain in the unit for long periods of time. Sediments or minerals can deposit on pump parts and freeze pump action. Follow these procedures after every use:

1. Flush detergent system by turning its detergent shut-off valves to “**Off**” position and run pressure washer with black spray tip. Flush for one to two minutes.

 **WARNING** The high pressure stream of water that this equipment produces could cut through skin and its underlying tissues, resulting in serious injury and possible amputation.

Spray gun traps high water pressure, even when engine is stopped and water is disconnected, which could result in serious injury.

- Keep high pressure hose connected to pump and spray gun while system is pressurized.
- ALWAYS point spray gun in safe direction, press red button and squeeze spray gun trigger to release high pressure, every time you stop engine.

2. Shut off engine, turn off water supply, point gun in a safe direction, press red button and squeeze trigger to relieve trapped pressure, and let engine cool.
3. Disconnect hose from spray gun and high pressure outlet on pump. Drain water from hose, gun, and nozzle extension. Use a rag to wipe off the hose.
4. Place spray gun, nozzle extension, and spray tips in accessory holders. Coil high pressure hose on hose wrap.
5. Empty pump of all pumped liquids by pulling recoil handle about six times. This should remove most liquid in pump.
6. Store unit in a clean, dry area.
7. If storing for more than 30 days, see *Long Term Storage* on next page.

 **WARNING** Fuel and its vapors are extremely flammable and explosive which could cause burns, fire or explosion resulting in death, serious injury and/or property damage.

WHEN STORING FUEL OR EQUIPMENT WITH FUEL IN TANK

- Store away from furnaces, stoves, water heaters, clothes dryers, or other appliances that have pilot light or other ignition source because they could ignite fuel vapors.

Winter Storage

NOTICE You must protect your unit from freezing temperatures.

- Failure to do so will permanently damage your pump and render your unit inoperable.
- Freeze damage is not covered under warranty.

To protect the unit from freezing temperatures:

1. Empty all cleaning tanks as follows:
 - a. Disconnect hose connected to barbed hose fitting on pump. Place end of hose into suitable container.
 - b. Rotate one of the detergent shut-off valves to “**On**” position and open that tanks cover. Gravity will empty tank contents into container.
 - c. When first tank is empty, repeat step (b) for other tank, using a different container.
 - d. Reconnect hose to barbed hose fitting on pump. Add 0.5 liter of clean fresh water to each tank and close tanks covers.
2. Flush detergent system by selecting one tank, turning its detergent shut-off valve to “**On**” position and run pressure washer with black spray tip. Flush until first tank is empty. Turn its detergent shut-off valve to “**Off**” position. Flush other tank the same way.
3. Follow steps 2-5 in the previous section *After Each Use*.
4. Use pump saver, Model 6039, to treat pump. This minimizes freeze damage and lubricates pistons and seals.
5. If pump saver is not available, connect a 3-foot (1 m) section of garden hose to water inlet adapter. Pour RV-antifreeze (antifreeze without alcohol) into hose. Pull recoil handle twice. Disconnect 3-foot (1 m) hose.
6. Store unit in a clean, dry area.

Long Term Storage

If you do not plan to use the pressure washer for more than 30 days, you must prepare the engine and pump for long term storage.

Protect Fuel System

Fuel Additive:

Fuel can become stale when stored over 30 days. Stale fuel causes acid and gum deposits to form in the fuel system or on essential carburetor parts. To keep fuel fresh, use Briggs & Stratton® Advanced Formula Fuel Treatment & Stabilizer, available wherever Briggs & Stratton genuine service parts are sold.

For engines equipped with a FRESH START® fuel cap, use Briggs & Stratton FRESH START® available in a drip concentrate cartridge.

There is no need to drain gasoline from the engine if a fuel stabilizer is added according to instructions. Run the engine for 2 minutes to circulate the stabilizer throughout the fuel system before storage.

If gasoline in the engine has not been treated with a fuel stabilizer, it must be drained into an approved container. Run the engine until it stops from lack of fuel. The use of a fuel stabilizer in the storage container is recommended to maintain freshness.

Change Engine Oil

Drain engine oil from crankcase. Refill with recommended grade. See *Changing Engine Oil* in *Engine Maintenance*.

Protecting the Pump

To protect the pump from damage caused by mineral deposits or freezing, use PumpSaver, Model 6039, to treat pump. This prevents freeze damage and lubricates pistons and seals.

NOTICE PumpSaver is available as an optional accessory. It is not included with the pressure washer. Contact the nearest authorized service center to purchase PumpSaver.

NOTICE You must protect your unit from freezing temperatures.

- Failure to do so will permanently damage your pump and render your unit inoperable.
- Freeze damage is not covered under warranty.

To use PumpSaver, make sure the pressure washer is turned off and disconnected from supply water. Read and follow all instructions and warnings given on the PumpSaver container.

Other Storage Tips

1. DO NOT store fuel from one season to another unless it has been treated as described in *Protect Fuel System*.
2. Replace fuel container if it starts to rust. Rust and/or dirt in fuel can cause problems if it's used with this unit.
3. Cover unit with a suitable protective cover that does not retain moisture.

▲ WARNING Storage covers could cause a fire resulting in death, serious injury and/or property damage.

- DO NOT place a storage cover over a hot pressure washer.
- Let equipment cool for a sufficient time before placing the cover on the equipment.

4. Store unit in a clean and dry area.

Troubleshooting

Problem	Cause	Correction
Pump has following problems: failure to produce pressure, erratic pressure, chattering, loss of pressure, low water volume.	<ol style="list-style-type: none"> 1. Low pressure spray tip installed. 2. Water inlet is blocked. 3. Inadequate water supply. 4. Inlet hose is kinked or leaking. 5. Clogged inlet hose screen. 6. Water supply is over 100°F. 7. High pressure hose is blocked or leaks. 8. Spray gun leaks. 9. Spray tip is obstructed. 10. Pump is faulty. 	<ol style="list-style-type: none"> 1. Replace with high pressure spray tip. 2. Clear inlet. 3. Provide adequate water flow. 4. Straighten inlet hose, patch leak. 5. Check and clean inlet hose screen. 6. Provide cooler water supply. 7. Clear blocks in outlet hose or replace hose. 8. Replace spray gun. 9. Clean spray tip. 10. Contact local service facility.
Detergent fails to mix with spray.	<ol style="list-style-type: none"> 1. Detergent shut-off valve is in the "Off" position. 2. Detergent siphoning tube is clogged or cracked. 3. High pressure spray tip installed. 4. Check ball stuck in detergent siphoning system. 	<ol style="list-style-type: none"> 1. Rotate detergent shut-off valve to "On" position. 2. Clean or replace detergent siphoning tube. 3. Replace with low pressure spray tip. 4. Unstick check ball as described in <i>Detergent Siphoning Check Ball</i>.
Engine runs good at no-load but "bogs" when load is added.	Engine speed is too slow.	Move throttle control to FAST position. If engine still "bogs down", contact local service facility.
Engine will not start; starts and runs rough, or shuts down during operation.	<ol style="list-style-type: none"> 1. Low oil level. 2. Dirty air cleaner. 3. Out of fuel. 4. Stale fuel. 5. Spark plug wire not connected to spark plug. 6. Bad spark plug. 7. Water in fuel. 8. Excessively rich fuel mixture. 	<ol style="list-style-type: none"> 1. Fill crankcase to proper level. 2. Clean or replace air cleaner. 3. Fill fuel tank. 4. Drain fuel tank; fill with fresh fuel. 5. Connect wire to spark plug. 6. Replace spark plug. 7. Drain fuel tank; fill with fresh fuel. 8. Contact local service facility.
Engine lacks power.	Dirty air filter.	Replace air filter.

Warranties

California, U.S. EPA, and Briggs & Stratton Corporation Emissions Control Warranty Statement

Your Warranty Rights And Obligations

The California Air Resources Board, U.S. EPA, and Briggs & Stratton (B&S) are pleased to explain the emissions control system warranty on your Model Year 2011-2012 engine/equipment. In California, new small off-road engines and large spark ignited engines less than or equal to 1.0 liter must be designed, built, and equipped to meet the State's stringent anti-smog standards. B&S must warrant the emissions control system on your engine/equipment for the periods of time listed below provided there has been no abuse, neglect, or improper maintenance of your engine or equipment.

Your emissions control system may include parts such as the carburetor or fuel injection system, fuel tank, ignition system, and catalytic converter. Also included may be hoses, belts, connectors, sensors, and other emissions-related assemblies. Where a warrantable condition exists, B&S will repair your engine/equipment at no cost to you including diagnosis, parts, and labor.

Manufacturer's Warranty Coverage:

Small off-road engines and large spark ignited engines less than or equal to 1.0 liter are warranted for two years. If any emissions-related part on your engine/equipment is defective, the part will be repaired or replaced by B&S.

Owner's Warranty Responsibilities:

- As the engine/equipment owner, you are responsible for the performance of the required maintenance listed in your owner's manual. B&S recommends that you retain all receipts covering maintenance on your engine/equipment, but B&S cannot deny warranty solely for the lack of receipts or your failure to ensure the performance of all scheduled maintenance.
- As the engine/equipment owner, you should however be aware that B&S may deny you warranty coverage if your engine/equipment or a part has failed due to abuse, neglect, improper maintenance, or unapproved modifications.
- You are responsible for presenting your engine/equipment to a B&S distribution center, servicing dealer, or other equivalent entity, as applicable, as soon as a problem exists. The warranty repairs should be completed in a reasonable amount of time, not to exceed 30 days. If you have any questions regarding your warranty rights and responsibilities, you should contact B&S at (414) 259-5262.

Briggs & Stratton Emissions Control Warranty Provisions

The following are specific provisions relative to your Emissions Control Warranty Coverage. It is in addition to the B&S engine warranty for non-regulated engines found in the Operator's Manual.

1. Warranted Emissions Parts

Coverage under this warranty extends only to the parts listed below (the emissions control systems parts) to the extent these parts were present on the B&S engine and/or B&S supplied fuel system.

a. Fuel Metering System

- Cold start enrichment system (soft choke)
- Carburetor and internal parts
- Fuel pump
- Fuel line, fuel line fittings, clamps
- Fuel tank, cap and tether
- Carbon canister

b. Air Induction System

- Air cleaner
- Intake manifold
- Purge and vent line

c. Ignition System

- Spark plug(s)
- Magneto ignition system

d. Catalyst System

- Catalytic converter
- Exhaust manifold
- Air injection system or pulse valve

e. Miscellaneous Items Used in Above Systems

- Vacuum, temperature, position, time sensitive valves and switches
- Connectors and assemblies

2. Length of Coverage

For a period of two years from date of original purchase, B&S warrants to the original purchaser and each subsequent purchaser that the engine is designed, built, and equipped so as to conform with all applicable regulations adopted by the Air Resources Board; that it is free from defects in material and workmanship that could cause the failure of a warranted part; and that it is identical in all material respects to the engine described in the manufacturer's application for certification. The warranty period begins on the date the engine is originally purchased.

The warranty on emissions-related parts is as follows:

- Any warranted part that is not scheduled for replacement as required maintenance in the owner's manual supplied, is warranted for the warranty period stated above. If any such part fails during the period of warranty coverage, the part will be repaired or replaced by B&S at no charge to the owner. Any such part repaired or replaced under the warranty will be warranted for the remaining warranty period.
 - Any warranted part that is scheduled only for regular inspection in the owner's manual supplied, is warranted for the warranty period stated above. Any such part repaired or replaced under warranty will be warranted for the remaining warranty period.
 - Any warranted part that is scheduled for replacement as required maintenance in the owner's manual supplied, is warranted for the period of time prior to the first scheduled replacement point for that part. If the part fails prior to the first scheduled replacement, the part will be repaired or replaced by B&S at no charge to the owner. Any such part repaired or replaced under warranty will be warranted for the remainder of the period prior to the first scheduled replacement point for the part.
 - Add on or modified parts that are not exempted by the Air Resources Board may not be used. The use of any non exempted add on or modified parts by the owner will be grounds for disallowing a warranty claim. The manufacturer will not be liable to warrant failures of warranted parts caused by the use of a non exempted add on or modified part.
3. Consequential Coverage
Coverage shall extend to the failure of any engine components caused by the failure of any warranted emissions parts.
4. Claims and Coverage Exclusions
Warranty claims shall be filed according to the provisions of the B&S engine warranty policy. Warranty coverage does not apply to failures of emissions parts that are not original equipment B&S parts or to parts that fail due to abuse, neglect, or improper maintenance as set forth in the B&S engine warranty policy. B&S is not liable for warranty coverage of failures of emissions parts caused by the use of add-on or modified parts.

Look For Relevant Emissions Durability Period and Air Index Information On Your Small Off-Road Engine Emissions Label

Engines that are certified to meet the California Air Resources Board (CARB) small off-road Emissions Standard must display information regarding the Emissions Durability Period and the Air Index. Briggs & Stratton makes this information available to the consumer on our emissions labels. The engine emissions label will indicate certification information.

The **Emissions Durability Period** describes the number of hours of actual running time for which the engine is certified to be emissions compliant, assuming proper maintenance in accordance with the Operating & Maintenance Instructions. The following categories are used:

Moderate:

Engine is certified to be emissions compliant for 125 hours of actual engine running time.

Intermediate:

Engine is certified to be emissions compliant for 250 hours of actual engine running time.

Extended:

Engine is certified to be emissions compliant for 500 hours of actual engine running time.

For example, a typical walk-behind lawn mower is used 20 to 25 hours per year. Therefore, the **Emissions Durability Period** of an engine with an **intermediate** rating would equate to 10 to 12 years. Briggs & Stratton engines are certified to meet the United States Environmental Protection Agency (USEPA) Phase 2 emissions standards. For Phase 2 certified engines, the Emissions Compliance Period referred to on the Emissions Compliance label indicates the number of operating hours for which the engine has been shown to meet Federal emissions requirements.

For engines less than 225 cc displacement.

Category C = 125 hours

Category B = 250 hours

Category A = 500 hours

For engines of 225 cc or more displacement.

Category C = 250 hours

Category B = 500 hours

Category A = 1000 hours

BRIGGS & STRATTON POWER PRODUCTS GROUP, LLC PRESSURE WASHER OWNER WARRANTY POLICY

Effective April 1, 2012; replaces all undated Warranties and all Warranties dated before April 1, 2012.

LIMITED WARRANTY

Briggs & Stratton warrants that, during the warranty period specified below, it will repair or replace, free of charge, any part that is defective in material or workmanship or both. Transportation charges on product submitted for repair or replacement under this warranty must be borne by purchaser. This warranty is effective for and is subject to the time periods and conditions stated below. For warranty service, find the nearest Authorized Service Dealer in our dealer locator map at BRIGGSandSTRATTON.com. The purchaser must contact the Authorized Service Dealer, and then make the product available to the Authorized Service Dealer for inspection and testing.

There is no other express warranty. Implied warranties, including those of merchantability and fitness for a particular purpose, are limited to one year from purchase, or to the extent permitted by law. All other implied warranties are excluded. Liability for incidental or consequential damages are excluded to the extent exclusion is permitted by law. Some states or countries do not allow limitations on how long an implied warranty lasts, and some states or countries do not allow the exclusion or limitation of incidental or consequential damages, so the above limitation and exclusion may not apply to you. This warranty gives you specific legal rights and you may also have other rights which vary from state to state or country to country.**

WARRANTY PERIOD

Consumer Use	2 years
Commercial Use	90 days

** In Australia - Our goods come with guarantees that cannot be excluded under the Australian Consumer Law. You are entitled to a replacement or refund for a major failure and for compensation for any other reasonably foreseeable loss or damage. You are also entitled to have the goods repaired or replaced if the goods fail to be of acceptable quality and the failure does not amount to a major failure. For warranty service, find the nearest Authorized Service Dealer in our dealer locator map at BRIGGSandSTRATTON.COM, or by calling 1300 274 447, or by emailing or writing to salesenquires@briggsandstratton.com.au, Briggs & Stratton Australia Pty Ltd, 1 Moorebank Avenue, NSW, Australia, 2170.

The warranty period begins on the date of purchase by the first retail consumer or commercial end user, and continues for the period of time stated above. "Consumer use" means personal residential household use by a retail consumer. "Commercial use" means all other uses, including use for commercial, income producing or rental purposes. Once equipment has experienced commercial use, it shall thereafter be considered as commercial use for purposes of this warranty.

NO WARRANTY REGISTRATION IS NECESSARY TO OBTAIN WARRANTY ON BRIGGS & STRATTON PRODUCTS. SAVE YOUR PROOF OF PURCHASE RECEIPT. IF YOU DO NOT PROVIDE PROOF OF THE INITIAL PURCHASE DATE AT THE TIME WARRANTY SERVICE IS REQUESTED, THE MANUFACTURING DATE OF THE PRODUCT WILL BE USED TO DETERMINE THE WARRANTY PERIOD.

ABOUT YOUR WARRANTY

We welcome warranty repair and apologize to you for being inconvenienced. Any Authorized Service Dealer may perform warranty repairs. Most warranty repairs are handled routinely, but sometimes requests for warranty service may not be appropriate. For example, warranty service would not apply if equipment damage occurred because of misuse, lack of routine maintenance, shipping, handling, warehousing or improper installation. Similarly, the warranty is void if the manufacturing date or the serial number on the pressure washer or engine has been removed or the equipment has been altered or modified. During the warranty period, the Authorized Service Dealer, at its option, will repair or replace any part that, upon examination, is found to be defective under normal use and service. This warranty will not cover the following repairs and equipment:

- **Normal Wear:** Outdoor Power Equipment, like all mechanical devices, needs periodic parts and service to perform well. This warranty does not cover repair when normal use has exhausted the life of a part or the equipment.
- **Installation and Maintenance:** This warranty does not apply to equipment or parts that have been subjected to improper or unauthorized installation or alteration and modification, misuse, negligence, accident, overloading, overspeeding, improper maintenance, repair or storage so as, in our judgment, to adversely affect its performance and reliability. This warranty also does not cover normal maintenance such as air filters, adjustments, fuel system cleaning and obstruction (due to chemical, lime, dirt, and so forth).
- **Other Exclusions:** This warranty excludes wear items such as quick couplers, seals, o-rings, pumps that have been run without water supplied or damage or malfunctions resulting from accidents, abuse, modifications, alterations, or improper servicing or freezing or chemical deterioration. Accessory parts, such as guns, hoses, nozzle extensions (wands), and nozzles, are excluded from the product warranty. This warranty excludes used, reconditioned, and demonstration equipment and failures due to acts of God and other force majeure events beyond the manufacturers control.

198203E, Rev. D, 04/17/2012

BRIGGS & STRATTON POWER PRODUCTS GROUP, LLC
MILWAUKEE, WI, USA