

How to install your ecobee

Download the ecobee app

The ecobee app has instructions, step-by-step videos, and diagrams customized to your wiring setup. Register your ecobee after installation to unlock smart features like Amazon Alexa.



Important Information

Look out for these icons at the bottom of each step. They indicate useful tips and important reminders.



TIPS



WARNINGS

First things first. Here's what you'll find in the box:



SmartThermostat

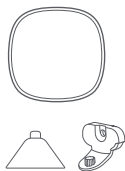

SmartSensor, stand,
and wall-mount

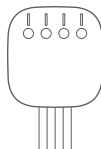

Power Extender
Kit (PEK)

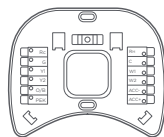

Backplate

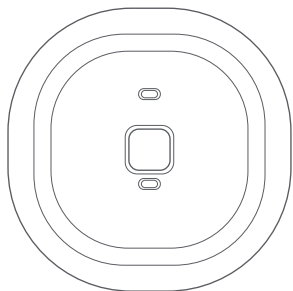

Trim plate

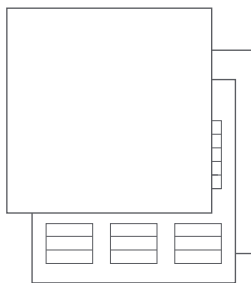

Install guide (this booklet)
quick start guide & wire labels



Screws
(x2)



Drywall plugs
(x2)

You may also need these tools:

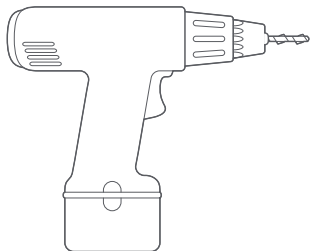

Drill for mounting anchors (3/16" drill bit)



Small flathead screwdriver



Phillips screwdriver

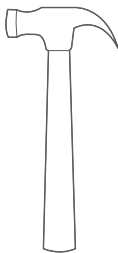

Hammer



Pencil

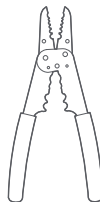

Wire stripper

STEP 1

Power off your Heating, Ventilation, and Air Conditioning (HVAC) system by using the master switch or circuit breaker box. **This is important for your safety.**

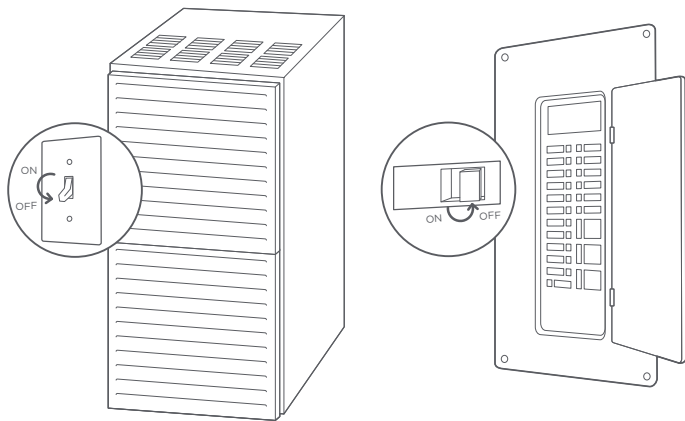

TIP: Look for your master switch or circuit breaker box in the basement, attic, utility closet, or behind a wall panel near the thermostat.

STEP 2

Confirm your system is off by turning on your heat (during winter) or your AC (during summer). Wait a few minutes—you should not feel air coming from your vents.

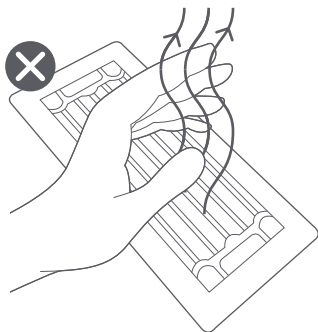
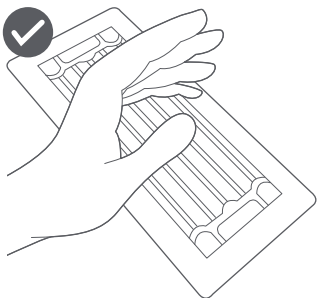

TIP: If you have a boiler, check to see that the main flame is extinguished.

STEP 3

Remove your old thermostat cover from the wall.

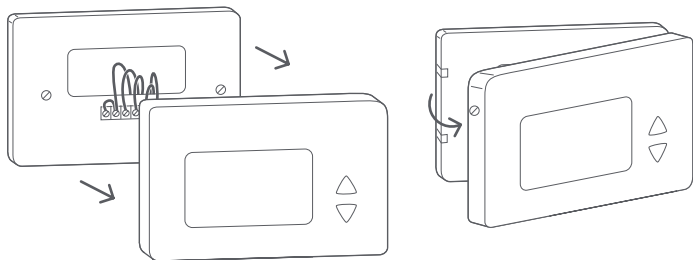

TIP: Many thermostats simply pop off or unclip from the base, while others may have screws that you will need to remove.

☑ CHECKPOINT: COMPATIBILITY

Does your old thermostat's backplate have any of these indicators?

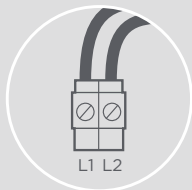

WARNING
HIGH VOLTAGE

110 VAC
OR
120 VAC
OR
240 VAC

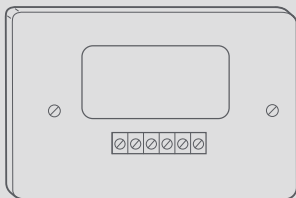

YES

Sadly, you might not be compatible.

you can double-check at ecobee.com/compatibility

NO

Great, please continue to the **NEXT PAGE.**

STEP 4

Take a picture of the wires connected to the terminals of your old thermostat. You may need to reference this photo later on.

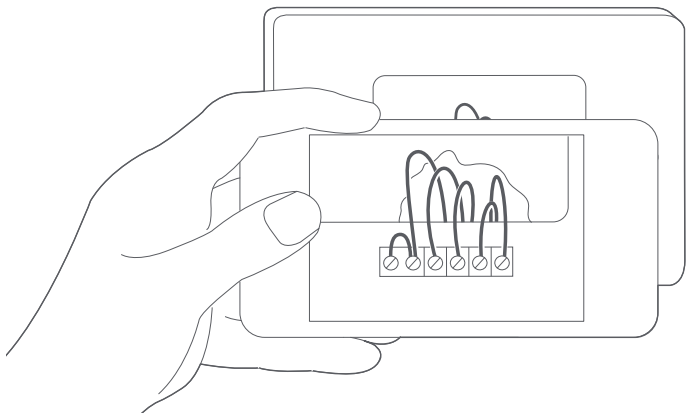

WARNING: ecobee is designed for 24VAC with a 2A maximum current. Do not connect it to line (high) voltage or millivolt systems.

✔ CHECKPOINT: C WIRE

Do you have a C wire connected to your old thermostat?

YES

Great! Continue to the **NEXT PAGE**.

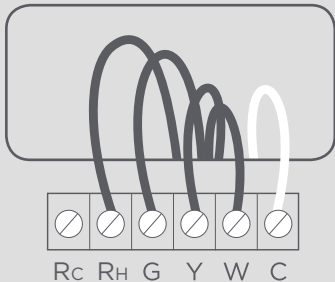

NO

Go to **PAGE 24** to install with a PEK.

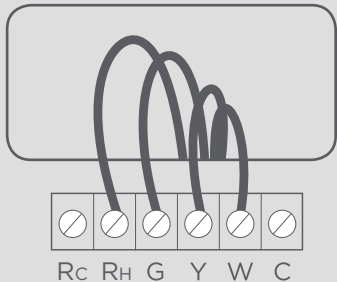

TIP: The wiring on your old thermostat may look different—just check to see if there's a C wire.

Install your ecobee with a C wire

If you have a C wire, it will power your ecobee. You won't need the Power Extender Kit (PEK) included in the box.

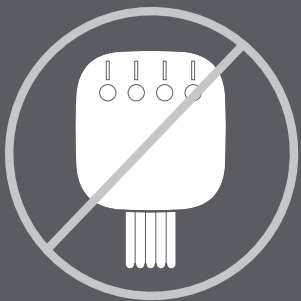

STEP 5

Carefully disconnect and label the wires from your old thermostat one at a time, using the labels provided.

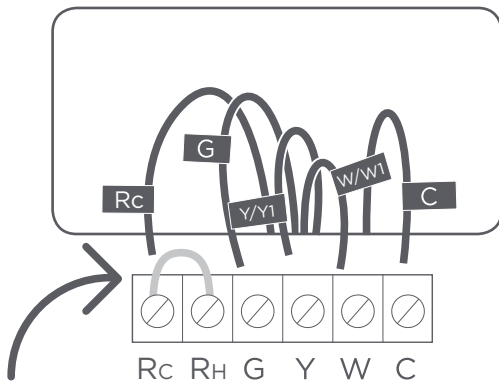

TIP: If you have a jumper between Rc, Rh, or R, leave it alone.
Only label the wires that run from your wall into a terminal block.

STEP 6

Unscrew the mounting plate of your old thermostat to remove it from the wall.

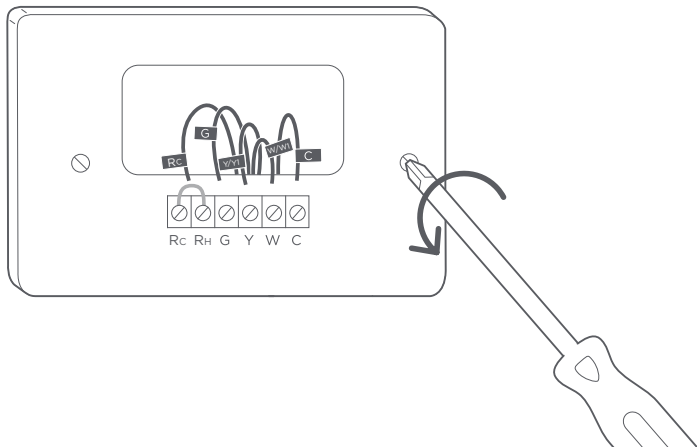

WARNING: Be careful, as some thermostats may contain mercury.
Recycle your old thermostat safely with your local hazardous waste facility.

STEP 7

Decide if you want to use the trim plate with your ecobee. The trim plate is useful if you want to hide marks or holes left on the wall by your old thermostat.

If using the trim plate, align the mounting holes on the trim plate and backplate and press them into place together.

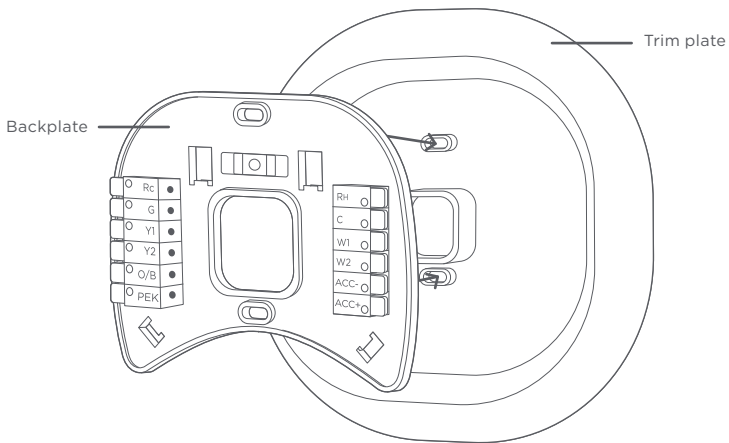

STEP 8

Pull the wires through the hole in the middle of the backplate and then attach the backplate to the wall using the drywall anchors and screws provided.

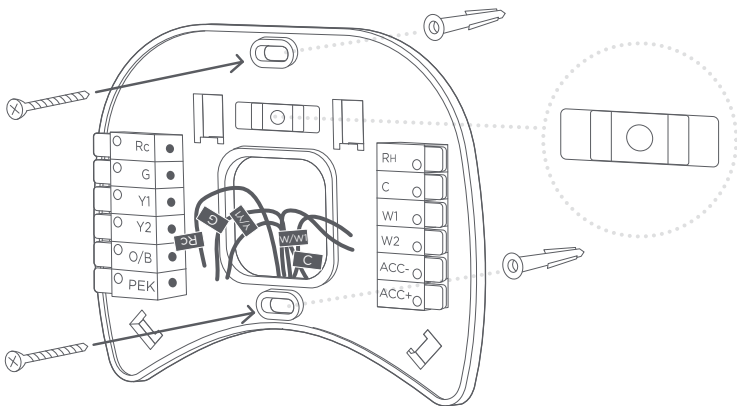

TIP: Use a 3/16" drill bit to drill a hole for the drywall anchors.

☑ CHECKPOINT: INSERT YOUR R WIRE(S)

Do you have more than one R wire?
(That includes R, Rc, and RH)

YES

Insert your wires:

R or Rc → Rc

RH → RH

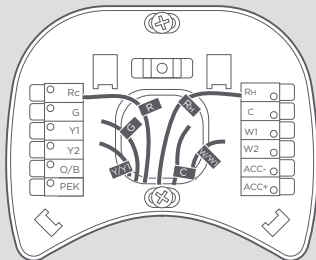

NO

Insert your single wire:

R, Rc, or RH → Rc

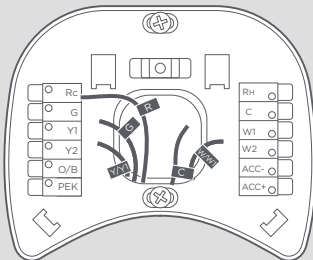

STEP 9

Insert your remaining wires into the side (not the front) of their corresponding terminal blocks.

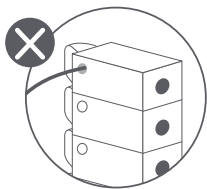
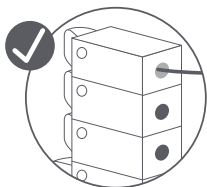
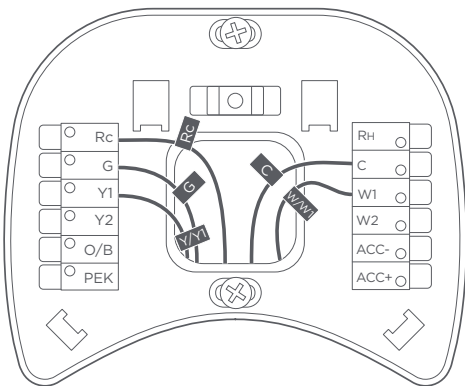

TIP: Press the terminal block levers to insert the wires more easily.

STEP 10

Tug on the wires gently to ensure they are securely connected.

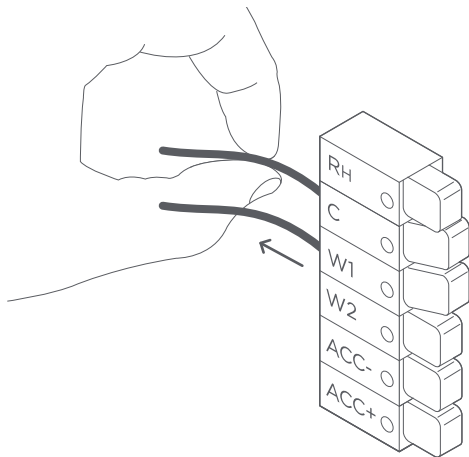

TIP: When a wire has been connected correctly, the lever on that block will lower.

STEP 11

Carefully push any excess wires back into the hole and ensure there are no drafts coming from the hole(s) in the wall.

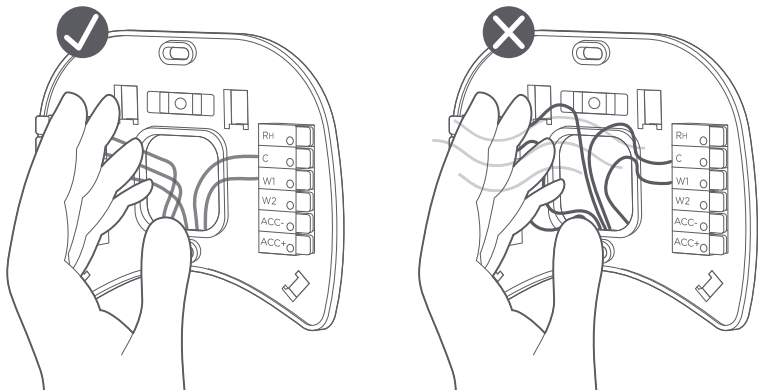

TIP: Large holes behind your thermostat will affect temperature readings. Prevent drafts by covering the hole(s).

STEP 12

Gently press your ecobee into the backplate until it 'clicks' into place.

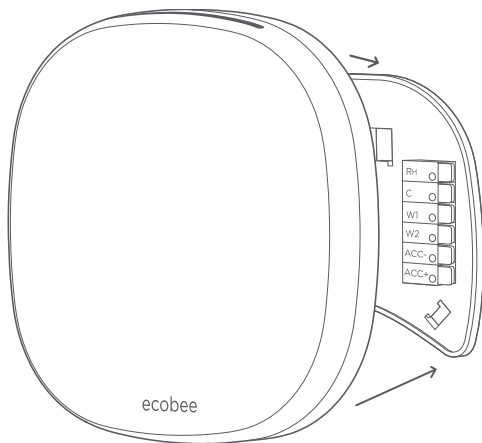

TIP: If the thermostat 'rocks' or is not flush with the wall, be sure the excess wires are pushed all the way into the wall.

STEP 13

Turn the power to your HVAC system back on using the master switch or at the circuit breaker box.

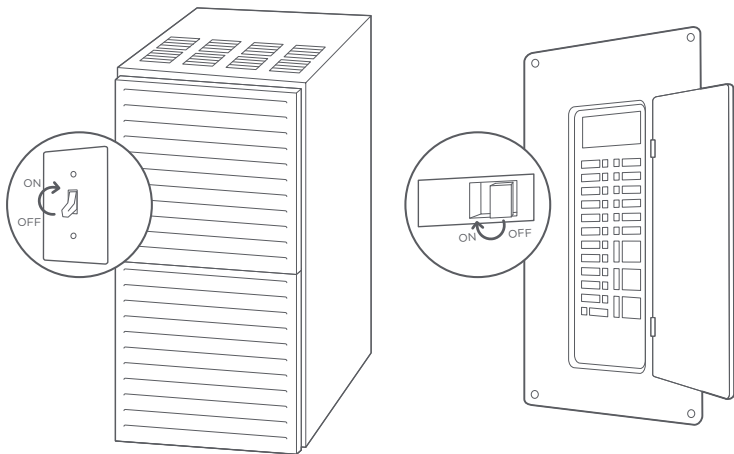

Congratulations, you did it!

Say hi to your new ecobee! To complete your setup and registrations, follow the instructions on your ecobee screen.

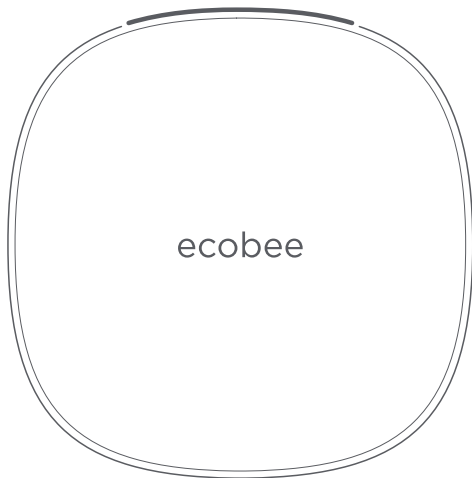

TIP: If your thermostat does not power on, please see the troubleshooting section on **PAGE 48**.

We can help you find a pro

Installation with the Power Extender Kit (PEK) will require you to handle electrical wiring. If you'd rather leave it up to a professional, we can help you find one quickly.

ecobee.com/proinstall

Install your ecobee without a C wire

If you don't have a C wire, you'll need to use the Power Extender Kit (PEK) included to reliably power your ecobee.

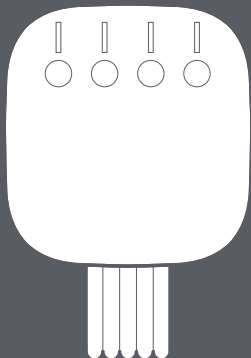



☑ CHECKPOINT: 3 OR 4 WIRES

The Power Extender Kit requires your system to have either of the following: **4 wires** W/W1, Y/Y1, G, and R (or Rc or RH) or **3 wires** Y/Y1, G, and R (or Rc or RH)

Do you have these wires?

YES

Continue to the
NEXT PAGE

The Power Extender Kit
will work with your system!



Rc RH G Y W C

NO

Contact us

Visit our compatibility checker
at ecobee.com/compatibility



Rc RH G Y W C



STEP 5

Take your Power Extender Kit, wire labels, tools, your smartphone, and go to your HVAC system.

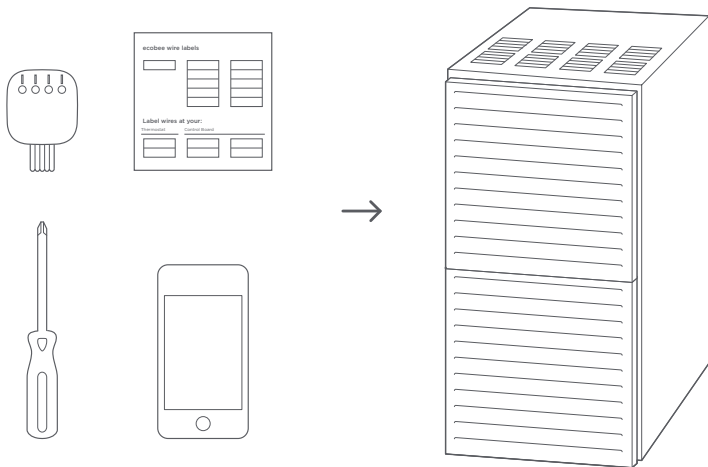

TIP: Your HVAC system can most often be found in your basement or your attic.



STEP 6

Open your HVAC system's cover to reveal the control board.

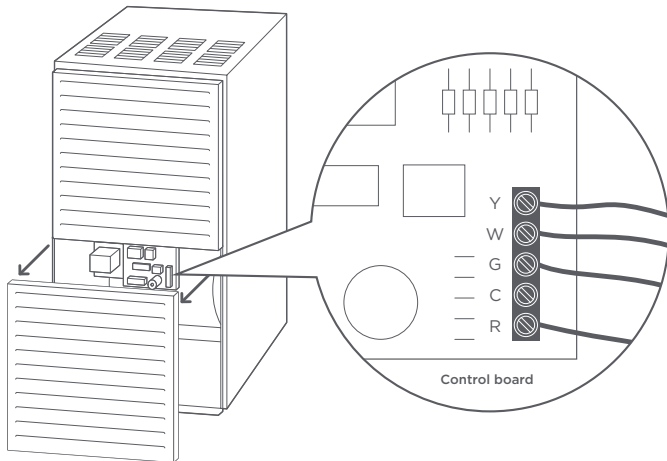

WARNING: HVAC systems contain high voltage wires. Use caution when working with the control board. If you'd rather leave it up to a professional, we can help you find one quickly. Visit ecobee.com/proinstall



STEP 7

Take a picture of the wires connected to your control board.
You may need to reference this photo later on.

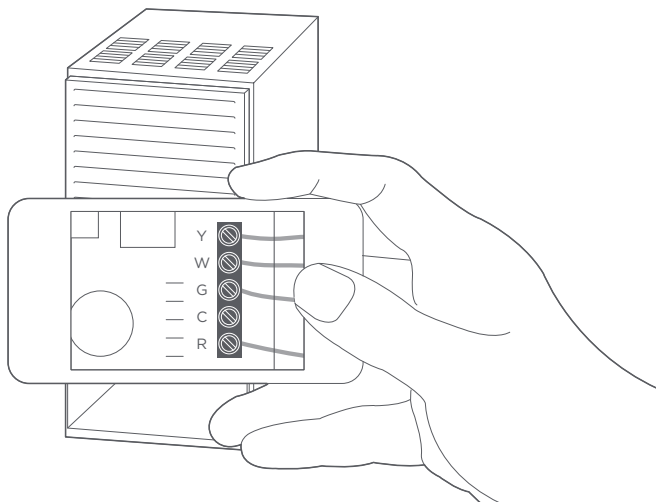



STEP 8

Label only the R, Y or Y1, G, and W or W1 wires with the matching labels provided. If you have more than one wire going into these terminals, only label those going to your thermostat.

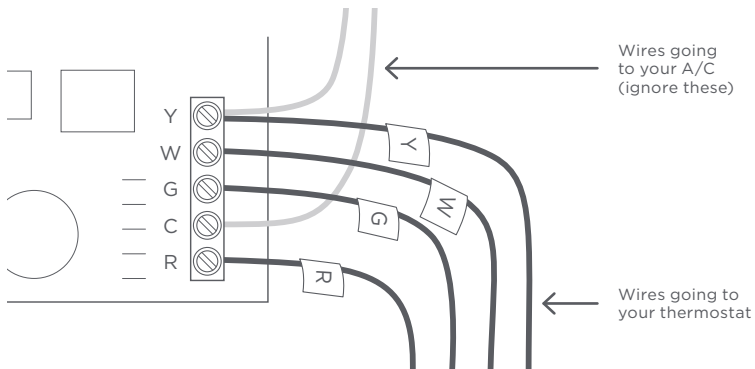

Find detailed step-by-step videos at ecobee.com/installation

TIP: If you have wires connected to both R_c and R_H terminals at the control board you may have a two transformer system. Please contact support to help you with installation: **1.877.932.6233** or support@ecobee.com.





STEP 9

Disconnect the wires labeled R, Y, G, and W from the control board.

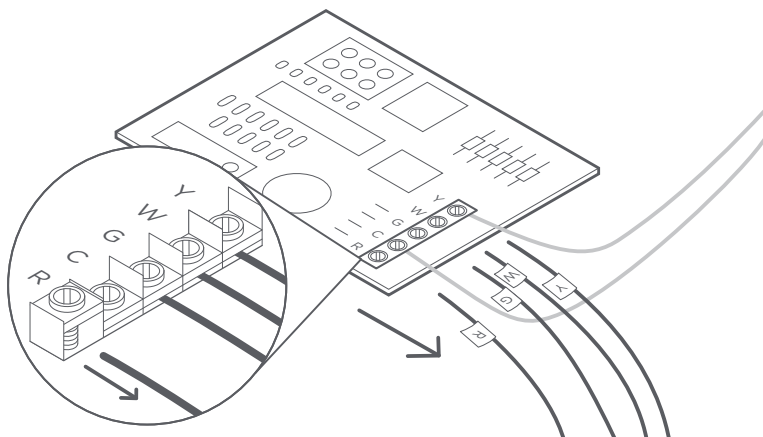

Find detailed step-by-step videos at ecobee.com/installation



STEP 10

Connect the wires you disconnected from the control board into their matching gray terminal blocks on the Power Extender Kit.

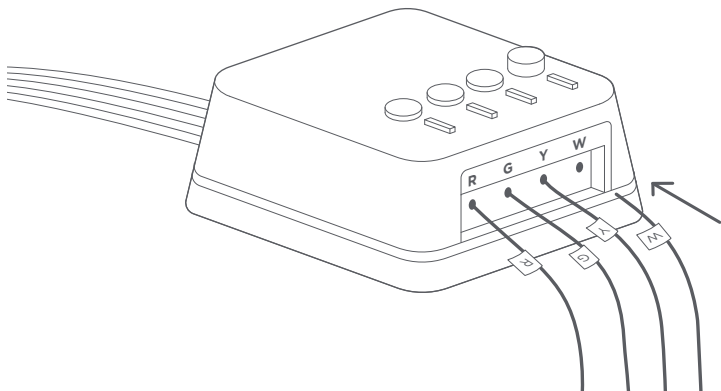

Find detailed step-by-step videos at ecobee.com/installation



TIP: Press the buttons to insert the wires more easily.



STEP 11

Tug on the wires gently to ensure they are securely connected.

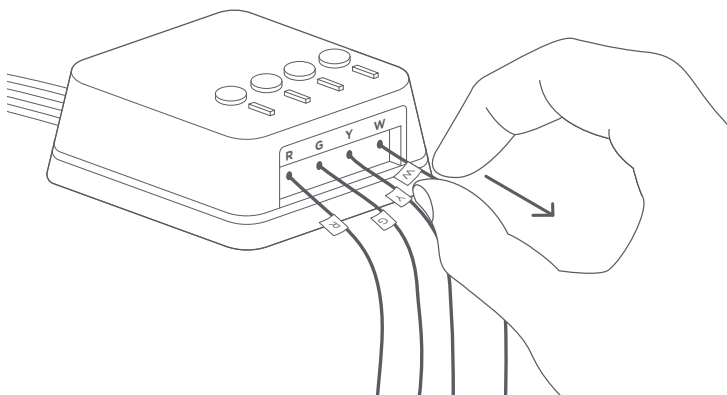

TIP: When a wire has been connected correctly, the button on that block will lower.



STEP 12

Connect the five white wires coming out of your Power Extender Kit to their corresponding terminals on the control board.

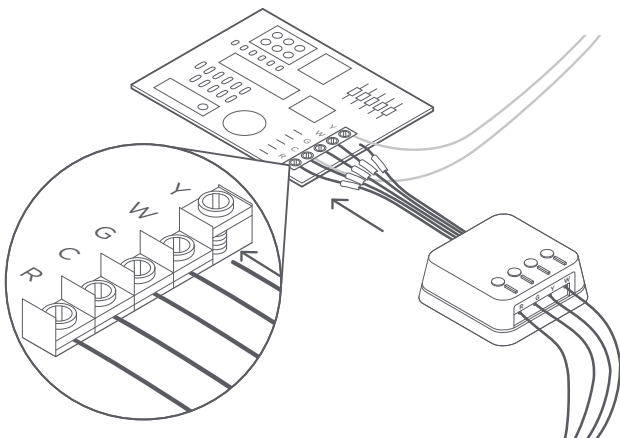

Find detailed step-by-step videos at ecobee.com/installation



TIP: Once again, tug on the wires gently to ensure they are securely connected.



✓ CHECKPOINT: POWER EXTENDER KIT

Check that you have installed the Power Extender Kit correctly. It should be installed between your thermostat wiring and your control board.

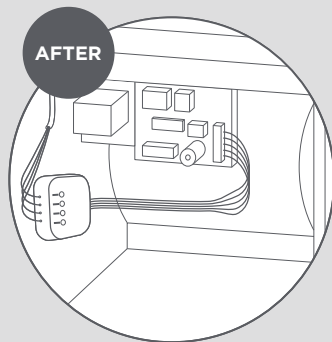
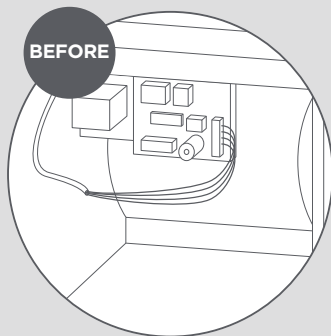



STEP 13

Mount the Power Extender Kit inside your HVAC system, taking care not to strain the wires. Close the HVAC cover panel securely and return to your thermostat.

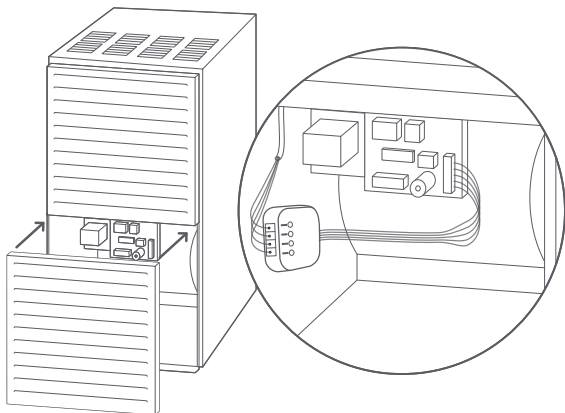

Find detailed step-by-step videos at ecobee.com/installation



TIP: Make sure your HVAC panel is fully closed. Some systems will not turn on if the cover panel has not been closed properly.



STEP 14

Back at your thermostat:

Carefully disconnect and label the wires from your old thermostat one at a time, using the labels provided. If you have a jumper between Rc, RH, or R, leave it alone. Only label the wires that run from your wall into a terminal block.

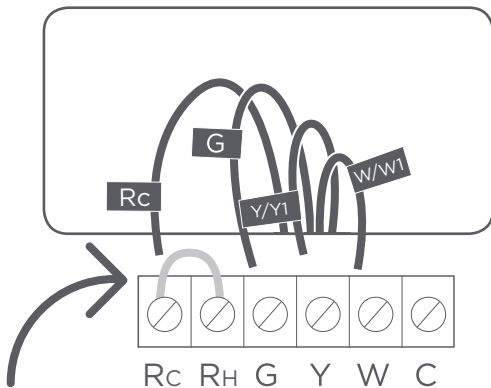



STEP 15

Unscrew the mounting plate of your old thermostat to remove it from the wall.

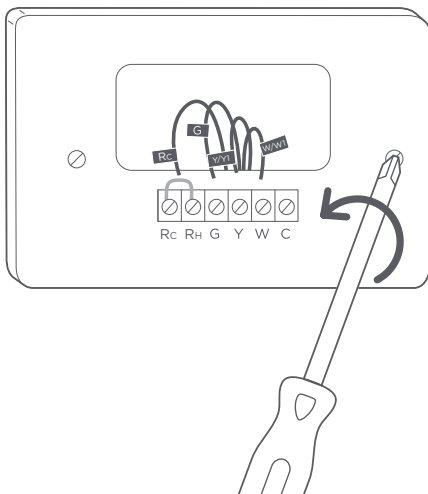

WARNING: Be careful, as some thermostats may contain mercury.
Recycle your old thermostat safely with your local hazardous waste facility.



STEP 16

Decide if you want to use the trim plate with your ecobee. The trim plate is useful if you want to hide marks or holes left on the wall by your old thermostat.

If using the trim plate, align the mounting holes on the trim plate and backplate and press them into place together.

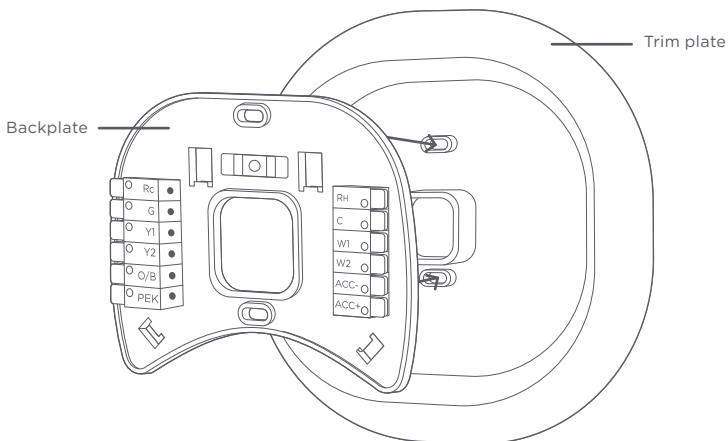



STEP 17

Pull the wires through the hole in the middle of the backplate and then attach it to the wall using the drywall anchors and screws provided.

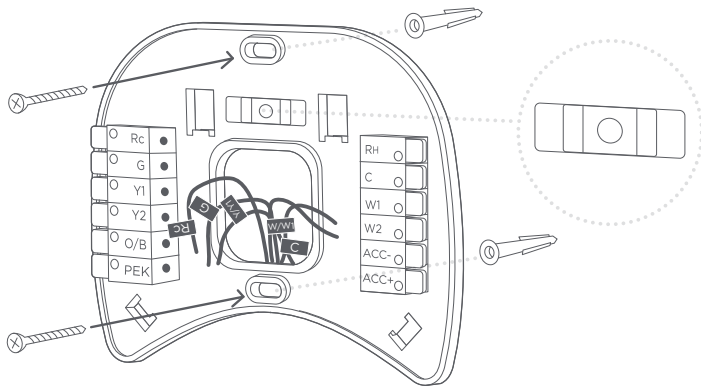

TIP: Use a 3/16" drill bit to drill a hole for the drywall anchors.



STEP 18

Remove the Rc, C, and PEK labels from the label sheet and attach them to the wires as shown below:

R/Rc/RH → Rc

G → C

Y → PEK

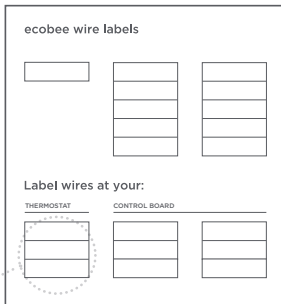
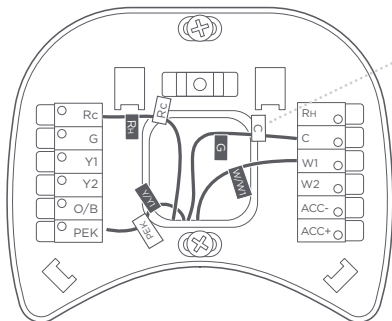



STEP 19

First, connect these 3 wires as shown: **Rc**, **C**, **PEK**.

Then, connect any remaining wires to their corresponding terminal.

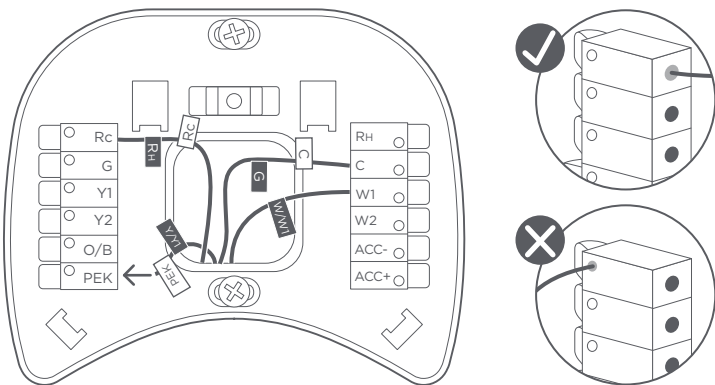

TIP: Press the terminal block levers to insert the wires more easily.



✔ CHECKPOINT: DON'T SKIP AHEAD

Did you connect the correct wires to the **Rc**, **C**, and **PEK** terminals, as shown below?

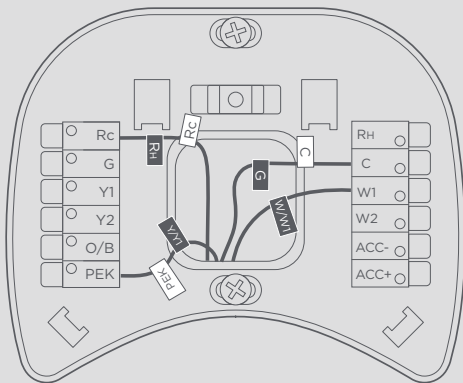

YES

Continue to the
NEXT PAGE.

NO

Please ensure that your
wiring is as **shown above.**



STEP 20

Tug on the wires gently to ensure they are securely connected.

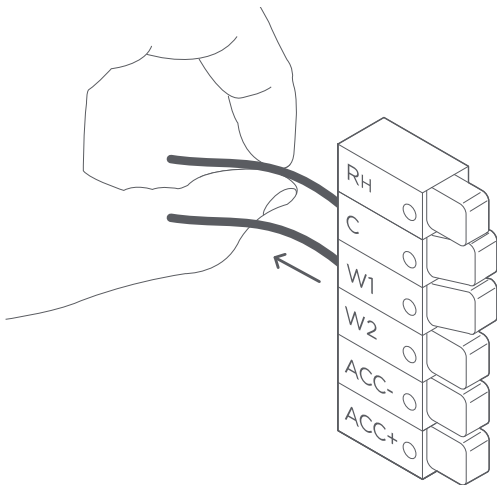

TIP: When a wire has been connected correctly, the lever on that block will lower.



STEP 21

Carefully push any excess wires back into the hole and ensure there are no drafts coming from the hole(s) in the wall.

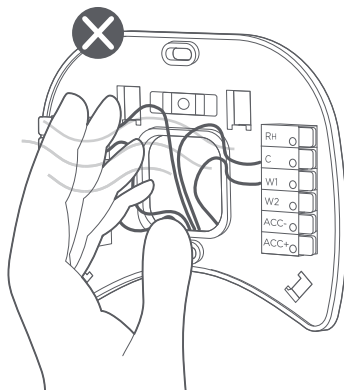
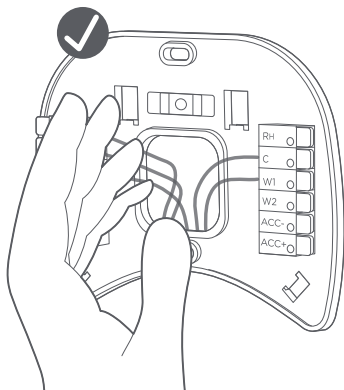

TIP: Large holes behind your thermostat will affect temperature readings. Prevent drafts by covering the hole(s).



STEP 22

Gently press your ecobee into the backplate until it 'clicks' into place.

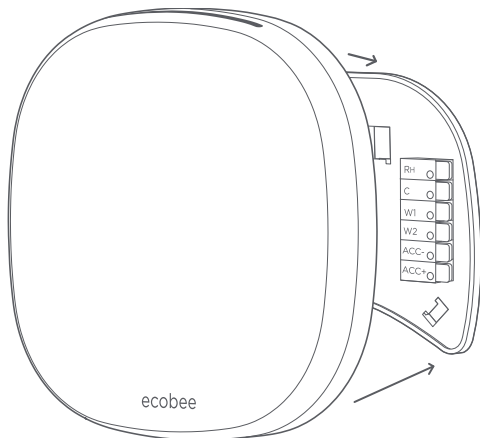

TIP: If the thermostat 'rocks' or is not flush with the wall, be sure the excess wires are pushed all the way into the wall.



STEP 23

Turn the power to your HVAC system back on using the master switch or at the circuit breaker box.

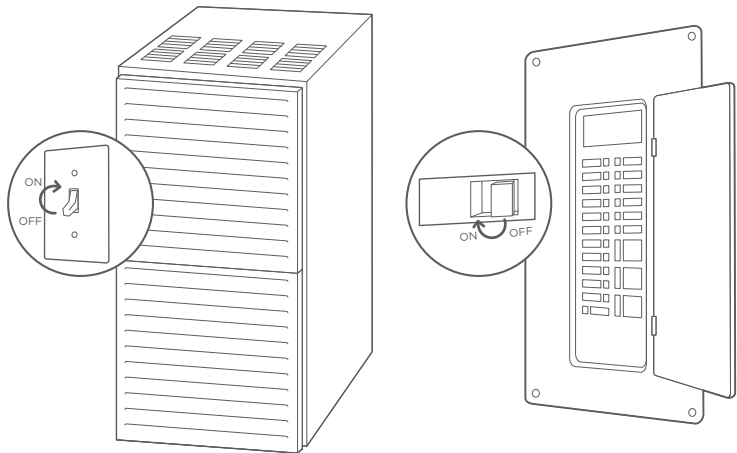



Congratulations, you did it!

Say hi to your new ecobee! To complete your setup and registrations, follow the instructions on your ecobee screen.



Troubleshooting

TROUBLESHOOTING

If your ecobee doesn't turn on, please try these steps:

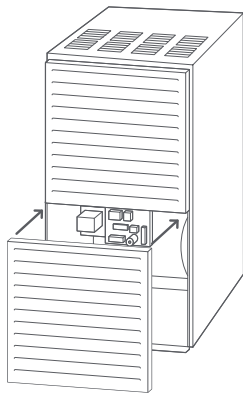
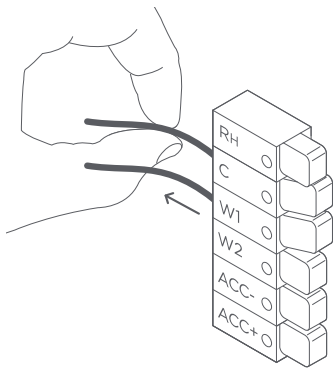

1. Check that all wires are properly inserted into the terminal blocks at the thermostat. Tug on the wires to ensure they are not loose.
2. Make sure your HVAC cover panel is closed. Some systems will not turn on if the cover panel has not been closed properly.

TROUBLESHOOTING

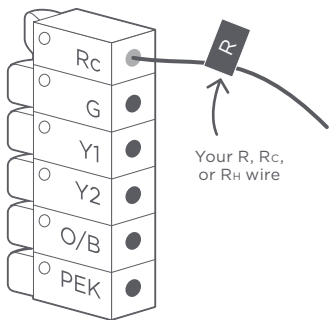

3. If you have only one R wire (either R, Rc, or Rh), make sure it's inserted into the Rc terminal.

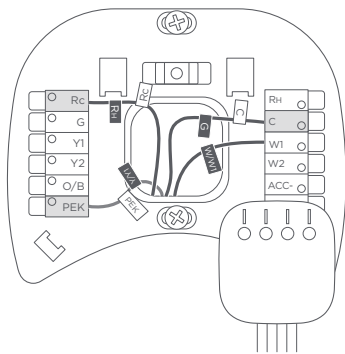

4. If you installed the Power Extender Kit, make sure you inserted the wires into the correct terminals.

Still need help?

WE'RE HERE FOR YOU

Have questions or concerns? Get in touch.

1.877.932.6233

ecobee.com/support

WE CAN HELP YOU FIND A PRO

Installation requires you to uninstall your old device and handle electrical wiring. If you'd rather leave it up to a professional, we can help you find one quickly.

ecobee.com/proinstall

INSTALLING ACCESSORIES?

To install accessories (humidifier, dehumidifier or ventilator) please refer to the wiring diagrams at **ecobee.com/wiring**

LEGAL

Approvals

This product was designed and built in accordance to RoHS directive 2002/95/EC and contains no hazardous substances as defined by this directive.

FCC Compliance Statement Compliance Notice:

This equipment has been tested and found to comply with the limits for a Class B digital device, pursuant to part 15 of the FCC Rules. These limits are designed to provide reasonable protection against harmful interference in a residential installation. This equipment generates, uses and can radiate radio frequency energy and, if not installed and used in accordance with the instructions, may cause harmful interference to radio communications. However, there is no guarantee that interference will not occur in a particular installation. If this equipment does cause harmful interference to radio or television reception, which can be determined by turning the equipment off and on, the user is encouraged to try to correct the interference by one or more of the following measures:

- Reorient or relocate the receiving antenna.
- Increase the separation between the equipment and receiver.
- Connect the equipment into an outlet on a circuit different from that to which the receiver is connected.
- Consult the dealer or an experienced radio/TV technician for help.

This device complies with part 15 of FCC rules. Operation is subject to the following two conditions:

1. This device may not cause harmful interference.
2. This device must accept any interference received, including interference that may cause undesired operation.

Change or modifications that are not expressly approved by the manufacturer could void the user's authority to operate the equipment.

RF Exposure Information:

This equipment complies with FCC radiation exposure limits set forth for an uncontrolled environment. In order to avoid the possibility of exceeding the FCC radio frequency exposure limits, human proximity to the antenna shall not be less than 8 inches during normal operation.

Innovation, Science and Economic Development Canada (ISED) | Compliance Notice:

This device contains licence-exempt transmitter(s)/ receiver(s) that comply with Innovation, Science and Economic Development Canada's licence-exempt RSS(s). Operation is subject to the following two conditions:

1. This device may not cause interference.
2. This device must accept any interference, including interference that may cause undesired operation of the device.

Innovation, Sciences et Développement économique Canada (ISDE) | Avis de conformité:

L'émetteur/récepteur exempt de licence contenu dans le présent appareil est conforme aux CNR d'Innovation, Sciences et Développement

économique Canada applicables aux appareils radio exempts de licence. L'exploitation est autorisée aux deux conditions suivantes :

1. L'appareil ne doit pas produire de brouillage;
2. L'appareil doit accepter tout brouillage radioélectrique subi, même si le brouillage est susceptible d'en compromettre le fonctionnement.

RF Exposure Statement:

This equipment complies with IC RSS-102 radiation exposure limits set forth for an uncontrolled environment. This transmitter must be installed to provide a separation distance of at least 8 inches from all persons and must not be collocated or operating in conjunction with any other antenna or transmitter.

Énoncé sur l'exposition aux fréquences radio :

Cet équipement est conforme aux limites d'exposition aux fréquences radio d'IC RSS-102 définies pour un environnement non contrôlé. Cet émetteur doit être installé à au moins 20 cm de toute personne et ne doit pas être colocalisé ou fonctionner en association avec une autre antenne ou émetteur.

FCC ID: WR92221123114
IC: 7981A-2221123114
CAN ICES-3 (B)/NMB-3(B)

Warning: Changes or modifications not expressly approved by ecobee Inc. could void the user's authority to operate the equipment

Avertissement : les changements qui ne sont pas expressément autorisés par ecobee Inc. pourraient annuler votre droit d'usage du matériel.

3-Year Limited Warranty

ecobee warrants that for a period of three (3) years

from the date of purchase by the consumer ("Customer"), the ecobee (the "Product") shall be free of defects in materials and workmanship under normal use and service. During the warranty period, ecobee shall, at its option, repair or replace any defective Products, at no charge. Any replacement and/or repaired device are warranted for the remainder of the original warranty or ninety (90) days, whichever is longer. A proof-of-purchase will be required from the Customer in order for ecobee to provide a replacement and/or repaired device. This Warranty is valid only for Product installed in the country in which it is purchased.

If the product is defective, call Customer Service at 1-877-932-6233. ecobee will make the determination whether a replacement product can be sent to you or whether the product should be returned to our address.

In the event of a failure of a Product, Customer may:

- a. If Customer did not purchase the Product directly from ecobee, contact the third party contractor from whom the Product was purchased to obtain an equivalent replacement product, provided the contractor determines that the returned Product is defective and Customer is otherwise eligible to receive a replacement product;
- b. Contact ecobee directly for service assistance at 1-877-932-6233 and ecobee will make the determination whether an advance equivalent replacement Product can be sent to Customer with return shipping supplies (in which case a hold shall be put on Customer's credit card for the value of the replacement Product until ecobee has received the defective Product). Product should be returned to our address. If the returned Product is found by ecobee to be defective and Customer is otherwise eligible to receive a replacement product, no amount shall be charged to Customer's credit card; or

c. Ship the defective Product directly to ecobee, in which case Customer shall contact ecobee directly at 1-877-932-6233, so ecobee can make the required shipping arrangements. Upon receipt of the defective Product, ecobee will ship an equivalent replacement product to Customer, provided the returned Product is found by ecobee to be defective and Customer is otherwise eligible to receive a replacement product.

This warranty does not cover removal or reinstallation costs and shall not apply if the damages were found to be caused by something other than defects in materials or workmanship, including without limitation, if the Product:

- Was operated/stored in abnormal use or maintenance conditions;
- Is repaired, modified or altered, unless ecobee expressly authorizes such repair, modification or alteration in writing;
- Was subject to abuse, neglect, electrical fault, improper handling, accident or acts of nature;
- Was not installed by a licensed Heating Ventilating and Air Conditioning (HVAC) contractor; or
- Was installed improperly.

ecobee's sole responsibility shall be to repair or replace the Product within the terms stated above. ECOBEE SHALL NOT BE LIABLE FOR ANY LOSS OR DAMAGE OF ANY KIND, INCLUDING ANY SPECIAL, INCIDENTAL OR CONSEQUENTIAL DAMAGES RESULTING, DIRECTLY OR INDIRECTLY, FROM ANY BREACH OF ANY WARRANTY, EXPRESS OR IMPLIED, OR ANY OTHER FAILURE OF THIS PRODUCT. Some US states and Canadian provinces do not allow the exclusion or limitation of incidental or consequential damages, so the above limitation or exclusion may not apply to you.

ecobee's responsibility for malfunctions and defects in materials and workmanship is limited to repair and replacement as set forth in this warranty statement. All express and implied warranties for the product, including but not limited to any implied warranties and conditions of merchantability and fitness for a particular purpose, are limited to the three-year duration of this limited warranty. No warranties, whether expressed or implied, will apply after the limited warranty period has expired. Some US states and Canadian provinces do not allow limitations on how long an implied warranty lasts, so this limitation may not apply.

ecobee neither assumes responsibility for nor authorizes any other person purporting to act on its behalf to modify or to change this warranty, nor to assume for it any other warranty or liability concerning this product.

This warranty gives you specific rights, and you may also have other rights which vary from jurisdiction to jurisdiction. If you have any questions regarding this warranty, please write to ecobee Customer Service.

Legal Notice

Use of the HomeKit™ Logo means that an electronic accessory has been designed to connect specifically to iPod®, iPhone®, or iPad®, respectively, and has been certified by the developer to meet Apple® performance standards. Apple is not responsible for the operation of this device or its compliance with safety and regulatory standards. Please note that the use of this accessory with iPod, iPhone, or iPad may affect wireless performance. Apple, iPhone, iPad, and iPod touch are trademarks of Apple Inc., registered in the U.S. and other countries. HomeKit is a trademark of Apple Inc.

We're here to help.

ecobee.com

support@ecobee.com

1.877.932.6233

© 2019 ecobee, Inc. All rights reserved. ecobee and the ecobee logo are trademarks of ecobee Inc., registered in the U.S. and other countries.



770-00092