

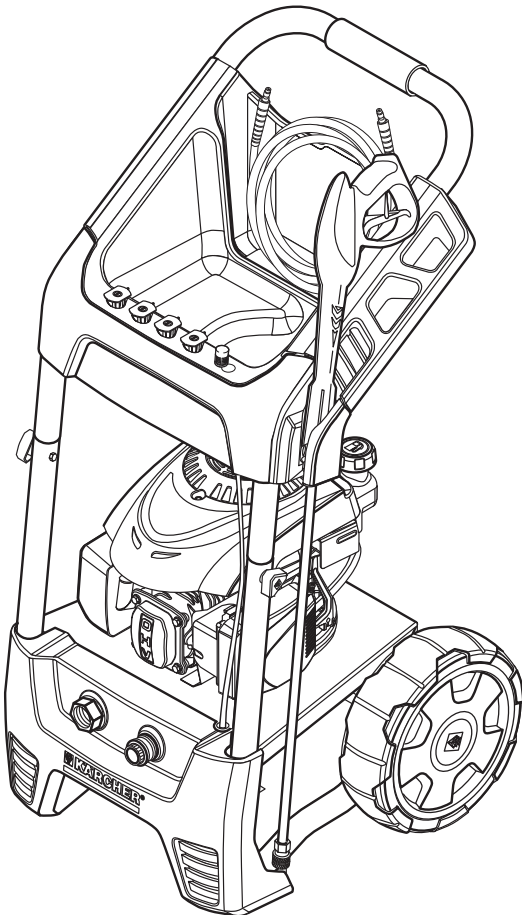

KÄRCHER®

G 2500 DC

G 2700 DC



8.751-078.0 02/12

HIGH PRESSURE WASHER OPERATOR MANUAL

Model Overview	3
Important Safety Instructions	4
Assembly Instructions	5
Operating Instructions	7
Using the Accessories	9
Working With Detergents	9
Taking a Break	10
Shutting Down & Clean-Up	10
Winterizing and Long-Term Storage	11
Maintenance Instructions	11
Cleaning Tips	11
Troubleshooting	13

Specifications

G 2500 DC	
Operating Pressure	2500 PSI
Water Volume	2.4 GPM
Detergent Suction	.15 - .20 GPM
Engine	Gasoline Engine 173 cc
Part No.	1.107-160.0
Serial No.	

G 2700 DC	
Operating Pressure	2700 PSI
Water Volume	2.4 GPM
Detergent Suction	.15 - .20 GPM
Engine	Gasoline Engine 173 cc
Part No.	1.107-161.0
Serial No.	

Safety Alert Symbols

DANGER

Indicates “an imminently hazardous situation which, if not avoided, will result in death or serious injury.”

WARNING

Indicates “a potentially hazardous situation which, if not avoided, could result in death or injury.”

CAUTION

Indicates “a potentially hazardous situation which, if not avoided, may result in minor or moderate injury or in property damage incidents.”

Owner/User Responsibility

The owner and/or user must have an understanding of the manufacturer's operating instructions and warnings before using this pressure washer. Warning information should be emphasized and understood. If the operator is not fluent in English, the manufacturer's instructions and warnings shall be read to and discussed with the operator in the operator's native language by the purchaser/owner, making sure that the operator comprehends its contents. Owner and/or user must study and maintain for future reference the manufacturers' instructions.

Kärcher Customer Support USA/ Canada

Call: **1-800-537-4129** for help or visit our website:

www.karcheresidential.com

Please take a moment to register your pressure washer online at:

www.karcheresidential.com/warranty

Kärcher Customer Support México

Call: **01-800-024-13-13** for help or visit our

website: **www.karcher.com.mx**

MODEL OVERVIEW

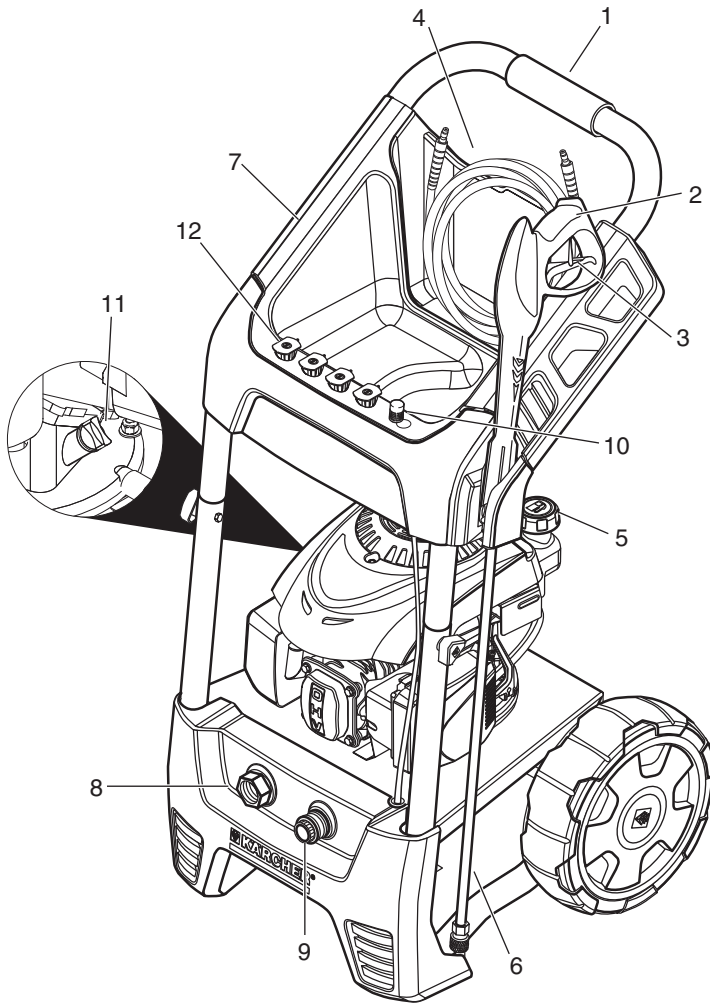

- | | |
|----------------------------|---|
| 1. Handle | 8. Water Inlet With Garden Hose Connector |
| 2. Trigger Gun | 9. Quick Connect High Pressure Outlet |
| 3. Trigger Gun Safety Lock | 10. Detergent suction tube with filter |
| 4. High Pressure Hose | 11. Dipstick |
| 5. Gas Tank | 12. Quick Connect Nozzles |
| 6. Spray Wand | |
| 7. Nozzle Holder | |

For Engine Details See Engine Manual

IMPORTANT SAFETY INSTRUCTIONS

- Read the operating instructions of the engine manufacturer before start-up and follow the safety instructions carefully.

WARNING

When using this product basic precautions should always be followed, including the following:

- Read all instructions before using product.
- To reduce the risk of injury, close supervision is necessary when a product is used near children.
- Know how to stop the product and bleed pressures quickly. Be thoroughly familiar with the controls.
- Stay alert – watch what you are doing.
- Do not operate when fatigued or under the influence of alcohol or drugs.
- Keep operating area clear of all persons.
- Do not overreach or stand on unstable support. Keep good footing and balance at all times.
- Wear safety goggles and ear protection.
- Follow the maintenance instructions specified in the manual.
- To avoid risks, all repairs and replacement of spare parts may only be carried out by trained personnel.

WARNING

Risk of Injection or Injury – Do Not Direct Discharge Stream At Persons.

- High pressure jets can be dangerous if misused. The jet must not be directed at persons, animals, electrical devices, or the unit itself.

DANGER

Do not spray electrical connections, electrical outlets or fixtures.

WARNING

Risk Of Explosion – Do not spray flammable liquids. Operate only where open flame or torch is permitted.

- Do not use acids, alkaline, solvents, or any flammable material in this product. These products can cause physical injuries to the operator and irreversible damage to the machine.

WARNING

Gun Kicks Back – Hold with both hands.

- The Trigger Gun Safety Lock prevents the trigger from accidentally being engaged. This safety feature must be engaged when replacing nozzles or not in use.

WARNING

The engine exhaust from this product contains chemicals known to the State of California to cause cancer, birth defects or other reproductive harm. Operation of this equipment may create sparks that can start fires around dry vegetation. A spark arrestor may be required. Operator should contact local fire agencies for laws or regulations.

CAUTION

Risk of Asphyxiation – Use this product only in a well ventilated area.

- Operate and fuel machine in a well ventilated area, free of devices featuring an open pilot or flame such as boilers, washer heaters, etc.

CAUTION

Risk of Fire – Do not add fuel when the product is operating or still hot.

CAUTION

Risk of fire - Do not put container with flammables products into the nozzle holder.

- Do not operate if fuel has been spilled. Instead, move machine to different location and avoid creating sparks.
- This machine has hot surfaces which can cause burns. Operate in a safe environment and away from children.
- Do not touch hot surfaces or allow accessories to contact hot surfaces.
- Do not leave machine running unattended.
- Avoid tipping machine on its side.

SAVE THESE INSTRUCTIONS

WATER SUPPLY (Cold Water Only)



⚠ CAUTION

When connecting to water supply mains, local regulations of your municipal water company must be observed. In some areas connecting directly to public drinking water supply may require a backflow prevention device. This is to ensure that there is no feedback of chemicals into the water supply. Use a water filter to avoid potential damage from dirt in the water supply.



- Garden hose must be at least 5/8 inch diameter.
- Flow rate of water supply must not fall below 2.5 GPM (gallons per minute)
- Flow rate can be determined by running the water for one minute into an empty 5-gallon container.
- The water supply temperature must not exceed 104°F/40°C.
- Never use the pressure washer to draw in water contaminated with solvents, e.g. paint thinners, gasoline, oil, etc.
- Always prevent debris from being drawn into the unit by using a clean water source. Use additional water filter.
- Do not operate pressure washer without the water turned on.

ASSEMBLY INSTRUCTIONS

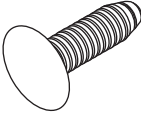
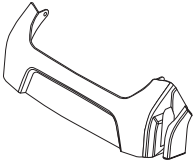
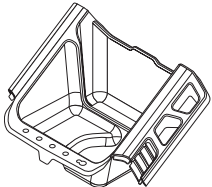
Hardware (included)

	Description	Purpose	Illustration	Qty
A	Knob 1/4"	Joint Assembly		2
B	1/4" Bolt	Joint Assembly		2
C	Nylon Rivet	Gun Holder Assembly		4
D	Gun Holder	Gun Holder Assembly		1
E	Nozzle Holder	Nozzle Holder Assembly		1

Hardware (included)

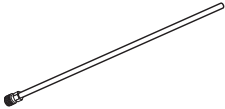
	Description	Purpose	Illustration	Qty
F	High Pressure Hose	Spray Gun Assembly		1
G	Spray Gun	Spray Gun Assembly		1
H	Quick Connect Nozzle Kit	Nozzles Kit Assembly		1
I	Wand	Wand Assembly		1

Assembling



Scan for detailed instructions

→ STEP 1:

Attach the handle to the frame of the pressure washer. Align holes, insert bolts (B), and tighten with knobs (A).

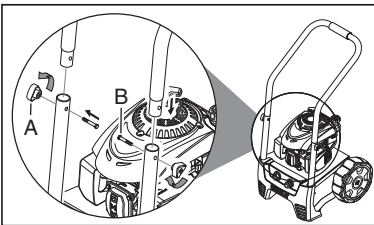

→ STEP 2:

Mount the gun holder (D) with enclosed nylon rivets (C) to the pressure washer handle.

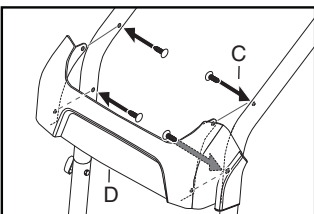

→ STEP 3:

Snap the nozzle holder (E) on to pressure washer handle and slide it down to the gun holder (D).

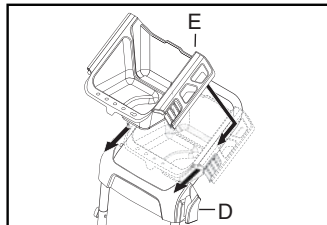

→ STEP 4:

Place the quick connect nozzles (H) in the nozzle holder (E) following the color instruction.

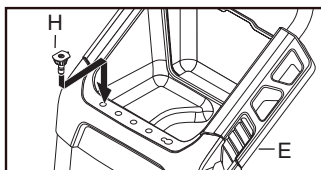

Assembling

→ STEP 5:

Attach the wand to the spray gun.

Push the wand (I) into the trigger gun (G) and then thread the connection.

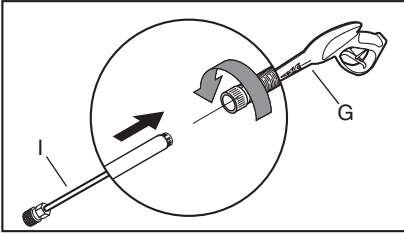

→ STEP 6:

Vertically insert the Spray Gun (G) into the Gun Holder (D).

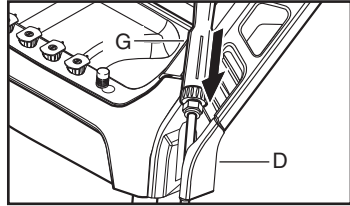

OPERATING INSTRUCTIONS

→ STEP 1:

Pull the spring-loaded collar of the wand back to insert your choice of quick connect nozzle.

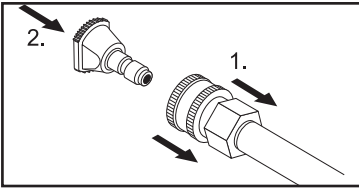

Release the collar and push the nozzle until the collar clicks.

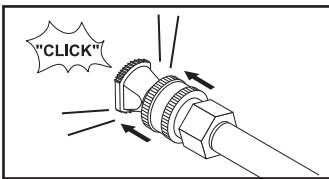

⚠ CAUTION

High pressure in nozzle area.

Risk of injury caused by improperly locked nozzle.

- Make sure you hear a "click" when inserting the nozzle tip in to the wand.
- Pull the nozzle to make sure it is seated properly before operating your unit.

→ STEP 2:

Pull back the spring loaded collar at the spray gun and insert the high pressure hose.

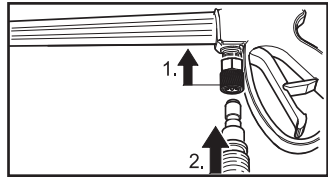

Release the collar and push the nozzle until the collar clicks.

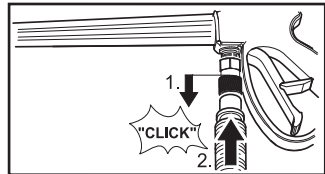

⚠ CAUTION

High pressure in quick connect area.

Risk of injury caused by improperly locked high pressure hose.

- Make sure you hear a "click" when inserting the high pressure hose in to the quick connection.
- Pull the high pressure hose to make sure it is seated properly before operating your unit.

OPERATING INSTRUCTIONS

⚠ CAUTION

Engine Shipped without oil. Before starting engine, fill with oil. Do not over-fill. Do not run the engine with a high or low oil level as this can cause engine damage.

If you have further questions regarding the engine, please refer to the engine manual included with the unit.

➔ STEP 3:

Check oil level. Oil level should always be between the "FULL" and "ADD" or "MAX" and "MIN" marks on the dipstick as shown in the picture below.

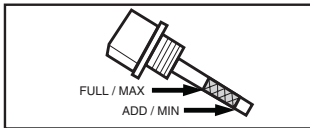

Be sure the machine is level when checking the oil level. (Refer to the engines operating manual for seasonal grades).

We recommend that the oil be changed after the first 5 hours of use, then once every 50 hours.

➔ STEP 4:

Fill gas tank with unleaded gasoline.

Do not use leaded gasoline.

Do not add oil to the gasoline.

➔ STEP 5:

Pull back the spring loaded collar at the high pressure outlet and insert the high pressure hose.

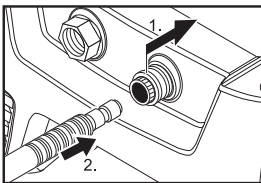

Release the collar and push the high pressure hose until the collar clicks.

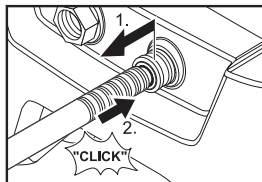

⚠ CAUTION

High pressure in quick connect area.

Risk of injury caused by improperly locked high pressure hose.

- Make sure you hear the "click" when inserting the high pressure hose into the quick connection.
- Pull the high pressure hose to make sure it is seated properly before operating your unit.

➔ STEP 6:

Connect garden hose to unit's water inlet.

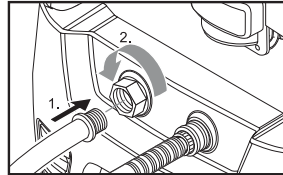

➔ STEP 7:

Connect garden hose to the cold water source and turn water completely on.

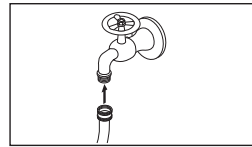

Do not use hot water.

➔ STEP 8:

Unlock the trigger gun safety lock. Trigger the gun to eliminate trapped air, wait for a steady flow of water to emerge from the spray nozzle.

➔ STEP 9:

Open fuel valve. Pull the choke rod to the ON position (on a warm engine, leave the choke rod in the OFF position).

➔ STEP 10:

Move the engine stop switch to the ON position.

➔ STEP 11 (RECOMMENDATION)

Hold the handle strongly and position a foot on the machine as shown in the pictures below.

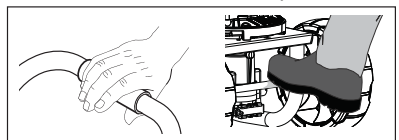

For engine details see engine manual.

OPERATING INSTRUCTIONS

→ STEP 12:

Pull the starter handle. If the engine fails to start after 3 pulls, squeeze the trigger gun to release pressure, and repeat step.

After the engine warms up enough to run smoothly move choke rod to OFF position.

USING THE ACCESSORIES

Quick connect nozzles

The color-coded quick connect nozzles provide a wide array of spray widths from 0° to 65° and are easily accessible when placed in the convenient nozzle holder.

0° spray angle = Red nozzle

For particularly stubborn accumulation of grime. **Not recommended** for soft materials like sidings, decks, painted surfaces, cars.

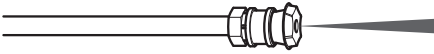

25° spray angle = Green nozzle

For dirt accumulation over a large surface.

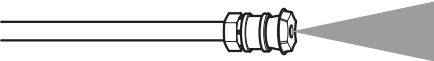

40° spray angle = White nozzle

For moderate dirt accumulation over a large surface.

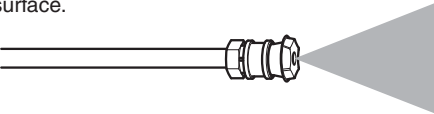

65° spray angle = Black nozzle

For operating with detergents or cleaning with low pressure.

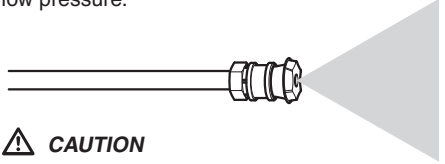

⚠ CAUTION

High pressure in nozzle area. Risk of injury caused by improperly locked nozzle.

- Make sure you hear the "click" when inserting the nozzle tip into the quick connection.
- Pull the nozzle to make sure it is seated properly before operating your unit. (See OPERATING INSTRUCTIONS: Step 1)

⚠ WARNING

To avoid serious injury never point spray nozzle at yourself, other persons or animals.

WORKING WITH DETERGENTS

Detergents can only be applied with the black detergent nozzle.

→ STEP 1:

Install the black detergent nozzle for detergent application at low pressure.

→ STEP 2:

Fill a container with Kärcher detergent. Place the filter end of detergent suction tube into the container.

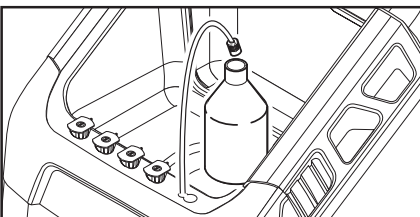

→ STEP 3:

With the engine running, pull trigger to operate unit.

Liquid detergent is drawn into the unit and mixed with water.

Apply detergent to work area.

Do not allow detergent to dry on surface.

→ STEP 4:

Always draw fresh water through the detergent suction tube when the cleaning job is done, to rinse/flush any remaining detergents from the injection system.

For best results see Cleaning Tips for specific information on how to clean different surfaces.

Detergents

CAUTION

This unit has been designed for use with cleaning detergents recommended by the manufacturer.

The use of other cleaning detergent may affect the operation of the machine and void the warranty.

Always Use Kärcher Detergent for Best Results

Kärcher biodegradable detergents are specially formulated to protect the environment and your pressure washer. The special formula won't clog the suction tube filter and will protect the internal parts of the pressure washer for a longer life. For Kärcher Detergents, check your retailer or visit our website:

www.karcherresidential.com/detergents

CAUTION

Never use:

- Bleach, Chlorine products and other corrosive chemicals
- Liquids containing solvents (i.e., paint thinners, gasoline, oils.)
- Tri-sodium phosphate products
- Ammonia products
- Acid-based products

These chemicals will harm the unit and will damage the surface being cleaned.

Use of these items will void the warranty.

TAKING A BREAK ...five minutes or more

→ STEP 1:

Move the engine stop switch to the OFF position.
For engine details see engine manual.

→ STEP 2:

Release trigger and engage safety lock.

SHUTTING DOWN & CLEAN-UP

→ STEP 1:

Remove detergent suction tube from container and insert into 1 gallon of fresh water. Siphon water at low pressure for one minute.

→ STEP 2:

Move the engine stop switch to the OFF position. Close the fuel valve.

→ STEP 3:

Turn off the water source.

→ STEP 4:

Press trigger to release water pressure.

→ STEP 5:

Release trigger and engage gun safety lock.

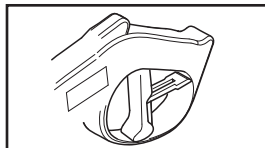

→ STEP 6:

Disconnect the garden hose from the water inlet on the unit.

→ STEP 7:

Disconnect the high pressure hose from the high pressure outlet. Store the high pressure hose in the nozzle holder assembly.

WINTERIZING AND LONG-TERM STORAGE

- ➔ **1:** Disconnect all water connections.
- ➔ **2:** Turn on the machine for a few seconds, until the water which had remained in the pump exits, turn off immediately.
- ➔ **3:** Do not allow high pressure hose to become kinked.
- ➔ **4:** Store the machine and accessories in a room which does not reach freezing temperatures. **DO NOT** store near furnace or other sources of heat as it may dry the pump seals.

CAUTION

Failure to follow the above directions will result in damage to the pump assembly and accessories and will void the warranty.

It is highly recommended to use Kärcher's Pump Guard (part number 9.558-998.0) before winter storage and during the cleaning season to protect the pump from freezing and premature wear.

MAINTENANCE INSTRUCTIONS

Kärcher pump

Initial Use

All Kärcher pumps ship with oil already inside direct from the factory. There is no need to add oil.

Pump Inspection

You should routinely make a visual inspection of the pressure washer's pump. If you notice oil leaking around the pump seals, you should take the pressure washer to a Kärcher-Authorized Service Center for repair. (You can locate a service center in your area online at: www.karcher-usa.com/service).

Pump Maintenance

The pump on your Kärcher pressure washer does not require maintenance. Any attempts to service or alter the pump may damage your pressure washer and void your product warranty.

Engine

Carry out maintenance tasks for the engine according to the specifications provided in the operating instructions provided by engine manufacturer.

CLEANING TIPS

Deck Cleaning

(with or without detergent). Pre-rinse deck and surrounding area with fresh water. If using Kärcher Deck Wash, apply to surface at low pressure. For best results, limit your work area to smaller sections of approximately 25 square feet. Allow Deck Wash to remain on surface 1-3 minutes. Do not allow detergent to dry on surface. Rinse at high pressure in a long sweeping motion keeping the spray nozzle approximately 3-6 inches from the cleaning surface. Always clean from top to bottom and from left to right. When moving on to a new section of the cleaning surface, be sure to overlap the previous section to eliminate stop marks and ensure a more even cleaning result.

House Siding

(with or without detergent). Pre-rinse cleaning surface with fresh water. If using Kärcher Pressure Wash, apply to surface at low pressure (for best results, limit your work area to sections of approximately 6 feet and always apply detergent from bottom to top). Allow detergent to remain on surface 1-3 minutes. Do not allow detergent to dry on surface, if surface appears to be drying, simply wet down surface with fresh water. If needed, use special wash brush attachment (not included) to remove stubborn dirt. Rinse at high pressure from top to bottom in an even sweeping motion keeping the spray nozzle approximately 6 inches from the cleaning surface.

Cement Patios, Brick and Stone

(with or without detergent). Pre-rinse cleaning surface with fresh water. If using Kärcher Pressure Wash or Degreaser, apply to surface at low pressure. For best results, limit your work area to smaller sections of approximately 25 square feet. Allow Pressure Wash or Degreaser to remain on surface 1-3 minutes. Do not allow detergent to dry on surface. Rinse at high pressure in a sweeping motion keeping the spray nozzle approximately 3- 6 inches from the cleaning surface. Always clean from top to bottom and from left to right. For removing extremely stubborn stains, use the Dirtblaster Nozzle.

Cars, Boats & Motorcycles

(with or without detergent). Pre-rinse vehicle with fresh water. If using Kärcher Touchless Vehicle Wash, apply to surface at low pressure. For best results, clean one side of vehicle at a time and always apply detergent from bottom to top, do not allow detergent to dry on surface. If needed, use special wash brush attachment (not included) to remove stubborn dirt. Rinse at high pressure in a sweeping motion keeping the spray nozzle approximately 6-8 inches from the cleaning surface

(distance should increase when rinsing pin-striping or other sensitive surfaces). Always clean from top to bottom and from left to right. For best results, wipe surface dry with a chamois or soft dry cloth.

Barbecue Grills, Outdoor Power Equipment & Gardening Tools

(with or without detergent). Pre-rinse cleaning surface with fresh water. If using Kärcher Pressure Wash or Degreaser, apply detergent at low pressure. Allow Pressure Wash to remain on surface 1-3 minutes. Do not allow detergent to dry on surface. Rinse at high pressure keeping the spray nozzle approximately 3-6 inches from the cleaning surface. For removing extremely stubborn dirt, it may be necessary to move the spray nozzle even closer to the surface for greater dirt cutting action.

Patio & Lawn Furniture

(with or without detergent). Pre-rinse furniture and surrounding area with fresh water. If using Pressure Wash, apply to surface at low pressure. Allow Pressure Wash to remain on surface 1-3 minutes. Do not allow detergent to dry on surface. If needed use special Wash Brush Attachment (not included) to remove stubborn dirt. Rinse at high pressure in a sweeping motion keeping the spray nozzle approximately 3-6 inches from the cleaning surface. For best results, clean from top to bottom and from left to right.

Recommendations

- Before cleaning any surface an inconspicuous area should be cleaned to test spray pattern and distance for maximum cleaning results.
- If painted surfaces are peeling or chipping, use extreme caution as pressure washer may remove the loose paint from the surface.
- When using on surfaces which might come in contact with food, flush surfaces with plenty of drinking water.
- For additional cleaning tips, visit our website at www.karcher-usa.com/home

Optional Accessories

Optional accessories are available to further enhance

your cleaning capabilities. These accessories are accurate as of the printing date of this manual. Please check our website:

www.karcherusa.com/home for pricing and up-to-date information.

- Extension Hose
- Dirtblaster spray nozzle

TROUBLESHOOTING

CAUTION

Remove the spark plug cable to prevent accidental ignition of the engine before making any repair

Symptom	Cause	Solution
ENGINE WILL NOT START	No gasoline	Fill gas tank
	Choke is not in the correct position	Slide choke lever out to closed position
	Water pressure built up in the machine	Squeeze the trigger to release the pressure
	For additional engine problems refer to the engine manual.	
UNIT DOES NOT REACH HIGH PRESURE	Diameter of garden hose is too small	Replace with a 5/8 inch or larger garden hose
	Water supply is restricted	Check garden hose for kinks, leaks and blockage
	Not enough inlet water supply	Turn water on full force. Check garden hose for kinks, leaks or blockage.
	Water inlet filter is clogged	Remove filter and rinse out in warm water
	Black detergent nozzle is attached	Remove black detergent nozzle and attach high pressure nozzle
OUTPUT PRES-SURE VARIES HIGH AND LOW	Not enough inlet water supply.	Turn water on full force. Check garden hose for kinks, leaks or blockage
	Pump is sucking air	Check that hoses and fittings are air tight. Turn off machine and purge pump by squeezing trigger gun until a steady flow of water emerges through the nozzle
	Water inlet filter is clogged	Remove filter and rinse out in warm water
	Spray nozzle is obstructed	Blow out or remove debris with a fine needle
	Calcified gun, hose or spray wand	Run distilled vinegar through detergent suction tube.

Symptom	Cause	Solution
NO DETERGENT.	Detergent suction tube not properly connected to the machine	Check connection
	Detergent is too thick	Dilute detergent, for best results use Kärcher detergent
	Filter on detergent suction tube is clogged	Run warm water through filter to remove debris
	Damaged or clogged detergent suction tube	Remove obstruction or replace detergent suction tube
	A high pressure nozzle is attached	Replace with black detergent nozzle
	Spray nozzle is obstructed	Blow out or remove debris with fine needle
GARDEN HOSE CONNECTION LEAKS	Loose fittings	Tighten fittings
	Missing/worn rubber washer	Insert new washer
SPRAY WAND LEAKS	Spray wand not properly attached	Turn the swivel nut of the gun clockwise until connection is tight
	Broken o-ring or plastic insert	Call Customer Support
PUMP IS NOISY	Not enough gas or engine oil	Check that hoses and fittings are air tight. Turn off machine and purge pump by squeezing trigger gun until a steady flow of water emerges through the nozzle
WATER LEAKS FROM PUMP (UP TO 10 DROP PER MINUTE IS PERMISSIBLE)	Loose fittings	Tighten fittings
	Water seals are damaged or worn.	Call Customer Support
	Thermal protection device is activated.	Thermal protection device will auto reset. Do not run pump for more than 5 minutes without spraying
OIL DRIP	Oil seals are damaged or worn	Call Customer Support

If the symptom you are experiencing is not listed above, or if the provided solutions do not solve your issue, please visit our extensive online troubleshooting database at:

www.karcherresidential.com/help.