



1800 PSI Pressure Washer

Owner's Manual



Model No. PWE1800

For Service Please Call Toll Free: 1-866-591-8921

⚠ WARNING ⚠

Read and follow all safety rules and instructions in this manual before attempting to operate this machine. Failure to comply with these instructions may result in personal injury.

Diagrams within this manual may not be drawn proportionally. Due to continuing improvements, the actual product may differ slightly from the product described herein.

1800 PSI Pressure Washer

Table Of Contents

Topic	Page #
Important Safety Tips, Precautions, Warnings, and Usage Instructions	2-5
Assembly Instructions	6-8
Operating Instructions	9-12
Detergents	12-13
Clean-up and Storage	14-15
Cleaning Tips	16
Technical Data	17
Troubleshooting Tips	18
Limited Warranty	19-20
Parts	21-23

1800 PSI Pressure Washer

GROUND FAULT CIRCUIT INTERRUPTER (GFCI)

This pressure washer is provided with a ground fault circuit interrupter (GFCI) built into the plug of the power supply cord. This device provides additional protection from the risk of electric shock. Should replacement of the plug or cord become necessary, use only identical replacement parts that include GFCI protection.

This unit is equipped with a Ground Fault Circuit Interrupter (GFCI). When connecting the GFCI to the receptacle, the indicator should appear red. If the indicator is not red, depress the RESET button on the GFCI until the indicator appears red. If the indicator does not appear red, please see Section titled "Troubleshooting" for more information.

IMPORTANT SAFETY TIPS

Never point the high pressure nozzle at people or animals.

Never drink alcohol or use drugs while operating the pressure washer.
--

Never operate the pressure washer while standing in water.

Never touch the electrical plug with wet hands.
--

Never let the electrical connections rest in water.
--

Never operate the pressure washer without the water turned on.

Never use hot water with this pressure washer.

1800 PSI Pressure Washer

IMPORTANT SAFETY PRECAUTIONS

WARNING: When using this product, basic precautions should always be followed, including the following:

- | |
|---|
| 1. Read all instructions before using the product. Save all safety instructions. |
| 2. Do not operate the pressure washer when fatigued or under the influence of alcohol or drugs. |
| 3. Risk infection or injury do not direct the high pressure water stream at any people or animals. |
| 4. Do not allow children to operate the pressure washer at any time. |
| 5. To reduce the risk of injury, close supervision is necessary when the pressure washer is used near children. |
| 6. Know how to stop the unit and reduce pressure immediately. Be completely familiar with the controls. |
| 7. Stay alert always be aware of where you are directing the high pressure spray |
| 8. Keep cleaning area clear of all people. |
| 9. Main safe footing and balance at all times do not overreach or stand on an unstable support. |
| 10. The work area should have adequate drainage to reduce the possibility of a fall due to slippery surfaces. |
| 11. Follow the maintenance instructions specified in the manual. |
| 12. To reduce the risk of electrocution, keep all connections dry and off the ground. Do not touch the plug with wet hands. |

GENERAL SAFETY PRECAUTIONS

- | |
|--|
| 1. Intended for outdoor household use only. |
| 2. High pressure hose can develop leaks from wear, abuse, kinking etc. Do not use a damaged hose. |
| 3. Do not use the pressure washer in areas near combustible materials, combustible fumes, or dust. |
| 4. Some chemicals or detergents may be harmful if inhaled or ingested causing severe injury. Use a respirator or mask whenever there is a chance that vapors may be inhaled. |

1800 PSI Pressure Washer

Read all instructions included with the mask so you are certain the mask will provide the necessary protection against inhaling harmful vapors.
5. Before starting the pressure washer in cold weather, check all of the parts of the equipment and be sure that ice has not formed. Do not store the unit anywhere that the temperature will fall below 0°C (32°F).
6. DO NOT MAKE ANY MODIFICATIONS TO ANY OF THE COMPONENTS! Units with broken or missing parts, or without the protective housing or covers should NEVER be operated
7. Keep the high pressure hose connected to the pressure washer and the spray gun while the system is pressurized. Disconnecting the hose while the unit is pressurized is dangerous, and may cause injury.
8. Do not leave the pressure washer unattended while the power switch is ON.
9. Keep the water spray away from electrical wiring or fatal electric shock may result.

SERVICING OF A DOUBLE-INSULATED APPLIANCE

In a double insulated product, two systems of insulation are provided instead of grounding. No means of grounding is provided on a double insulated product, nor should a means for grounding be added to the product. Servicing a double insulated product requires extreme care and knowledge of the system, and should be done only by qualified service personnel. Replacement parts for a double insulated product must be identical to the parts they replace. A double insulated product is marked with the words "DOUBLE INSULATION" or "DOUBLE INSULATED". This symbol  may also be marked on the product.

USE OF EXTENSION CORDS

Use of an extension cord with this product is NOT RECOMMENDED. If you must use an extension cord, use only extension cords that are intended for outdoor use. These cords are identified by a marking "ACCEPTABLE FOR USE WITH OUTDOOR APPLIANCES, STORE INDOORS WHILE NOT IN USE." Use only extension cords having an

1800 PSI Pressure Washer

electrical rating not less than the rating of the product. Examine the extension cord before use. Do not use damaged extension cords! Do not pull on cord to disconnect from the receptacle always disconnect by pulling on plug. Keep the cord away from heat and sharp edges. Always disconnect the extension cord from the receptacle before disconnecting the product from the extension cord.

WARNING To reduce the risk of electrocution, keep all connections dry and off the ground. Do not touch the plug with wet hands.

PROPER USE OF THE PRESSURE WASHER

***THIS UNIT IS INTENDED FOR USE WITH COLD WATER ONLY!
DO NOT USE HOT WATER IN THIS PRESSURE WASHER.***

1. Operate the pressure washer at no more than the fluid pressure rated for the pressure washer. Never run the pressure washer without a water supply. Running the unit without a water supply will cause irreparable damage to the unit.
2. Make sure that the water supply you use for the pressure washer is not dirty, sandy, and does not hold any corrosive chemical products. Using a dirty water supply will compromise the life of the pressure washer.
3. CAUTION The pressure washer can be used for a variety of applications including washing cars, boats, patios, decks, garages etc. where high pressure is necessary to remove dirt and debris. High pressure water flow can damage the work surface if not used properly! See the section titled "Operating Instructions" for more details. Always test the spray in an open area first.
4. NEVER move the unit by pulling on the high pressure hose. Use the handle provided on the top of the unit.
5. Always hold the high pressure gun and wand with two hands. Keep one hand on the gun/trigger, while supporting the wand with the other hand (see diagram).
6. When dispensing detergent, the pressure washer applies detergent to the cleaning area at low pressure only. Once the detergent has been applied, spray the detergent off of the work area by using the adjustable nozzle.

1800PSI Pressure Washer

ASSEMBLY INSTRUCTIONS

Unpacking The Carton

After opening the carton, please remove all parts and check them against the following list of components that are included:

- | | |
|-------------------------|--|
| A. High Pressure Washer | E. Two way Connector |
| B. Gun | F. Water Intake Filter (Pre Installed) |
| C. High Pressure Hose | G. Detergent Bottle |
| D. Adjustable Nozzle | H. Gun Shelf |

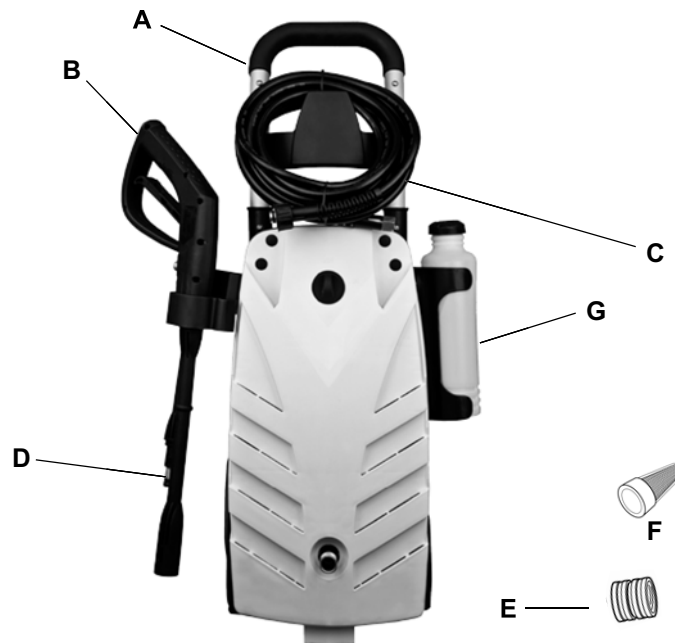

To assemble the enclosed parts, please refer to the steps that follow:

1800 PSI Pressure Washer

Step 1

Attach the high pressure hose to the gun. Use a wrench to tighten the fitting.

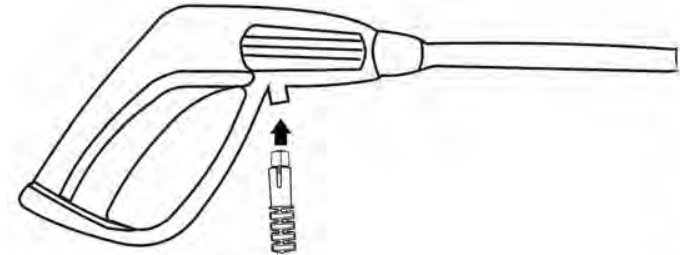

Step 2

Insert the adjustable spray nozzle into the gun. Push and turn the adjustable nozzle clockwise onto the gun until it is hand tight and to lock it in place. When the pieces are joined properly, you cannot separate the two components by pulling out on the adjustable nozzle. All attachments must be inserted into the gun for proper use.

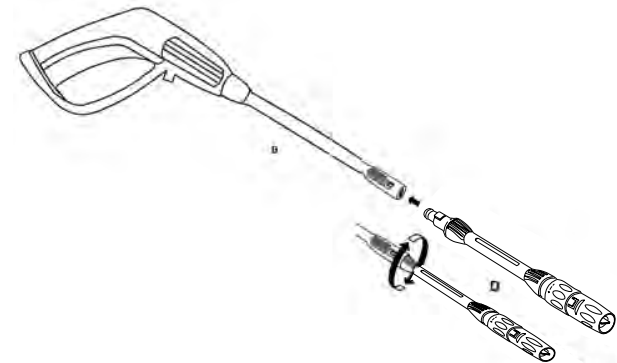

1800 PSI Pressure Washer

Step 3

Attach the high pressure hose to the male fitting on the front of the pressure washer. Before attaching the high pressure hose to the male fitting, remove the plastic cap, which covers fitting before shipping. This plastic cap can be discarded once removed. Hand tighten to avoid leakage.

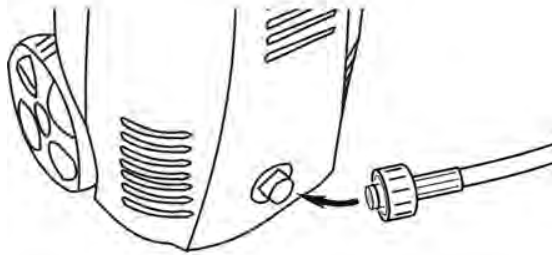

Step 4

Attach the hose connector to pressure washer. Before attaching the connector to the male fitting, remove the plastic cap, which is inserted onto the male fitting on the pressure washer before shipping. This plastic cap can be discarded once removed. After both components have been installed, attach the garden hose with connector screw on the pressure washer. Connect the garden hose to the waterspout.

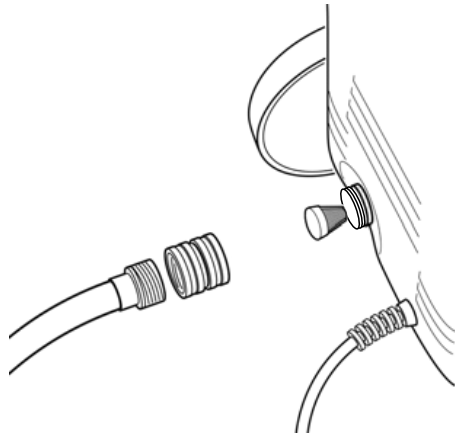

1800 PSI Pressure Washer

OPERATING INSTRUCTIONS

***THIS UNIT IS INTENDED TO BE USED WITH COLD WATER ONLY!
DO NOT USE HOT WATER IN THIS PRESSURE WASHER!***

Starting Up

After connecting the pressure washer to your cold water supply, proceed as follows:

Make sure that the on/off switch is in the off position.

Connect the garden hose with a quick connect to the inlet fitting.

Attach the hose to the gun as per assembly instruction step #1.

Insert the adjustable spray nozzle into the gun as per assembly step #2.

Connect the high pressure hose to the high pressure outlet fitting as per assembly step #3.

Open the water supply valve completely.

Before turning the unit on, press the gun trigger to bleed all the remaining air out of the pump and hose.

Start the pressure washer by turning the on/off switch to the on position and squeeze the trigger.

REMINDER: The Motor does not run continuously, only when the trigger is squeezed.

WARNING – Risk of injury the Unit will start spraying when trigger is squeezed. When turning the unit off after use, high pressure still exists inside the hose and unit. Point the gun in a safe direction and discharge the excess pressure. NEVER direct the high pressure water stream at people or animals.



1800 PSI Pressure Washer

Automatic On / Off

The pressure washer is equipped with an automatic on/off switch. The pressure washer will only run when the power switch is in the ON position and the trigger on the gun is squeezed. When you release the trigger to stop spraying water through the gun, the motor on the pressure washer will automatically shut off. Simply squeeze the trigger again to resume using the washer. To stop using the pressure washer, release the trigger and switch the unit to the OFF position. The unit should be turned completely OFF while not in use or while unattended.

Bleeding The Gun

It is very important to bleed all the air out of the pressure washer before using it. To do this

1. Release trigger lock.
 2. Squeeze the trigger before turning the electrical supply on. This removes any air trapped inside the pressure washer and lance before using the units.
 3. Continue holding trigger for approximately one minute to allow any excess air out of the unit. Water will flow through the gun at low pressure during this procedure.
 4. Lock the trigger.
 5. Plug the main power cord into the electrical outlet.
 6. Release the trigger lock.
 7. Turn the ON/OFF switch clockwise to the I/ON position.
- The pressure washer is ready for operation.

Gun Safety Lock

This pressure washer is equipped with a gun trigger safety lock. When not using the pressure washer, use the safety lock to protect from accidentally engaging the high pressure spray.

Adjustable Spray Nozzle

The adjustable nozzle will allow you to use a variety of spray patterns from a full fan spray (Diagram 1) to a direct stream spray (Diagram 2). When using the pressure washer to clean wood decks, siding, vehicles etc., always start using the fan spray and begin spraying from a minimum 36" away to avoid damaging the surface of the material you are cleaning. Always begin by spraying in a test area free and clear of people and objects.

1800 PSI Pressure Washer

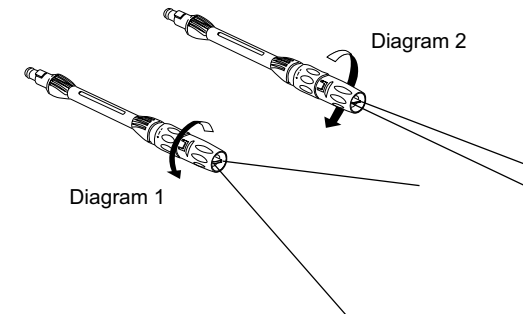

Dispensing Detergent

The built in detergent dispenser will allow you to apply liquid detergent onto the work surface. Detergent application happens at low pressure only. Insert the adjustable nozzle onto the gun, and turn it to end of “ - ” so that the pressure washer is in low pressure mode (see Figure A below). Remove the cap on the detergent reservoir and fill with liquid detergent only (see Figure B below). Do not put any water into the reservoir. The pressure washer will mix water and detergent automatically. When finished applying the detergent to the work surface, turn it to end of “ + ” of the adjustable nozzle and spray off the detergent by using the high pressure spray (see Figure A below). In high pressure mode, the pressure washer will not dispense detergent.

FIGURE A

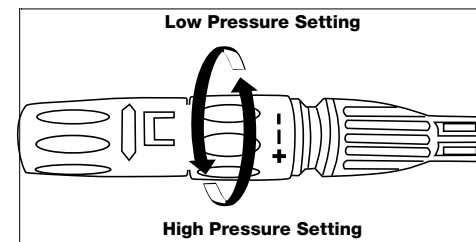

FIGURE B



1800 PSI Pressure Washer

ADJUSTING THE PRESSURE

To adjust the pressure, proceed as follows:

1. Hold the shaft of the lance in one hand.
2. Turn the grey part of the nozzle clockwise (to “+” end) to obtain the high pressure.
3. Turn the grey part of the nozzle anticlockwise (to “ ” end) to obtain the low pressure.

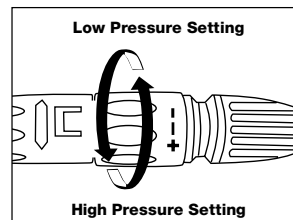

AUTO STOP SYSTEM

The pressure washer is fitted with an automatic stop system to protect the motor when in use.

When the trigger is released the motor will stop.

When the trigger is squeezed the motor will start up again.

USING DETERGENTS

The pressure washer will dispense detergent only at low pressure. Use the adjustable spray nozzle to apply detergents and to rinse clean.

Biodegradable detergents are specifically formulated to protect the environment and your pressure washer. These Detergents will not clog the filter and will protect the internal parts of the pressure washer for a longer life.



Step 1

Open the cover of the detergent reservoir by twisting it off.

Step 2

Fill the detergent reservoir with any approved liquid detergent. Close the cover.

1800 PSI Pressure Washer

Step 3

Remove the adjustable nozzle to end of “ ”, put the pressure washer into low pressure mode.

Low Pressure Setting

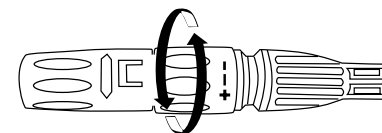

Step 4

To apply the detergent to your work area. Turn the pressure washer switch to the ON position. Pull the trigger to operate the unit. The pressure washer will mix the detergent with water. Do not allow the detergent to dry on the object that you are cleaning.

WARNING: NEVER USE PRODUCTS WITH BLEACH OR CHLORINE OR ANY OTHER CORROSIVE MATERIALS, INCLUDING LIQUIDS CONTAINING SOLVENTS (I.E. GAS, OILS ETC), TRI-SODIUM PHOSPHATE PRODUCTS, AMMONIA, OR ACID-BASED CLEANERS. THESE CHEMICALS WILL HARM THE UNIT AND CAUSE DAMAGE TO THE SURFACE BEING CLEANED. ALWAYS READ THE LABEL.

Step 5

To clean the working area, turn the adjustable nozzle to end of “ + ”, return it to high pressure mode. Spray high pressure water onto the work area to rinse off the work area and any remaining detergent.

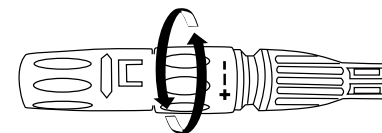

High Pressure Setting

1800 PSI Pressure Washer

CLEAN-UP AND STORAGE

Shutting Down the Pressure Washer

WHEN FINISHED USING THE PRESSURE WASHER, FOLLOW THESE STEPS TO SHUT DOWN THE UNIT:

- Turn the pressure washer to the OFF position.
- Turn off the water supply.
- Before disconnecting high pressure hose connection, point the gun in a safe direction and discharge the high pressure water.
- Disconnect high pressure hose from the pressure washer and gun.
- Disconnect garden hose from the pressure washer.
- Remove excess water from the pump by tipping the unit on both sides to drain any remaining water from the inlet and outlet fittings.
- Remove The Water Intake Filter and flush with water to remove dirt or debris. Return filter once it is cleaned.

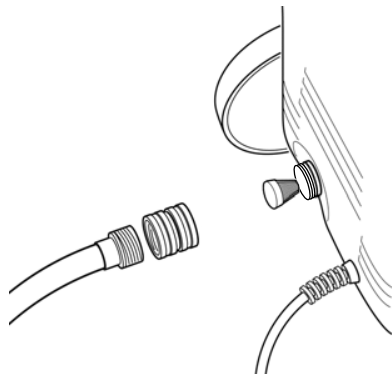

- Drain the detergent reservoir and flush with running water.
- Wipe away any remaining water on all parts and fittings.
- Engage the gun safety lock.
- Store the pressure washer, parts, and accessories in an area with a temperature above 0°C (32°F).

1800 PSI Pressure Washer

Winterizing and Long-Term Storage

FOLLOW ALL OF THE ABOVE SHUT-DOWN PROCEDURES, ADDING THE FOLLOWING STEPS....

- After disconnecting the water supply, and before disconnecting the high pressure hose, turn the pressure washer on for 2-3 seconds, until any remaining water in the pump exits. Turn the unit off immediately.

CONTINUED USE OF THE PRESSURE WASHER WITHOUT THE WATER SUPPLY ATTACHED WILL CAUSE SEVERE DAMAGE TO THE UNIT!

- Always store the pressure washer, parts, and accessories in an area with a temperature above 0° C (32° F).

WARNING: FAILURE TO COMPLY WITH THESE STORAGE INSTRUCTIONS WILL RESULT IN DAMAGE TO THE PUMP ASSEMBLY.

Maintenance

- This pressure washer is supplied with a closed lubrication system, so no addition of oil is needed.
- Check all hoses and accessories for damage prior to use.
- Check the water intake filter periodically for deposits. Clean this filter regularly for maximum performance.

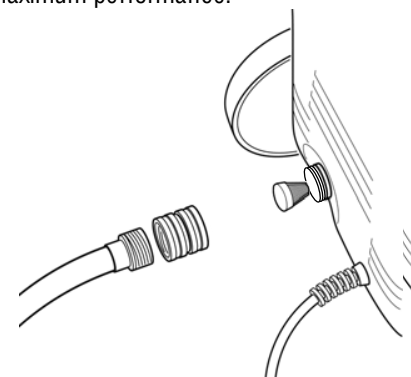

1800 PSI Pressure Washer

CLEANING TIPS

WARNING: ALWAYS TEST THE SPRAY IN AN AREA FREE AND CLEAR OF PEOPLE AND OBJECTS BEFORE YOU AIMING AT THE INTENDED CLEANING SURFACE.

Wood and Vinyl Decks

Rinse the area with fresh water. If using detergent, fill the detergent reservoir and apply to the area being cleaned at low pressure. For optimal results, reduce your work area to smaller sections and clean each section one at a time. Allow the detergent to rest on the surface for a few minutes and then rinse at high pressure. Do not let the cleanser dry. Always clean from left to right and top to bottom for best results. Rinse at high pressure using the fan spray keeping the tip of the spray nozzle at least 6-9 inches from the cleaning surface. Maintain a further distance from the cleaning area when using a direct spray.

Caution: For softer woods, increase the distance from the cleaning area.

Cement Patios, Stone, and Brick

Rinse the area with fresh water. If using detergent, fill the detergent reservoir and apply to the area being cleaned at low pressure. Rinse at high pressure using the fan spray in a sweeping motion keeping the tip of the spray nozzle at least 3-6 inches from the cleaning surface. Maintain a further distance from the cleaning area when using a direct spray.

Cars, Boats, and Motorcycles

Rinse the area with fresh water. If using detergent, fill the detergent reservoir and apply to the area being cleaned at low pressure. To achieve the best results, clean one side at a time. Allow the detergent to remain on the surface for a few minutes, but do not let the detergent dry. Rinse at high pressure using the fan spray in a sweeping motion keeping the tip of the spray nozzle at least 8 inches from the cleaning surface.

1800 PSI Pressure Washer

Maintain a greater distance from the cleaning area when using a direct spray. Wipe the surface dry for a polished finish.

Barbecue Grills, Power Equipment, and Garden Tools

Rinse the area with fresh water. If using detergent, fill the detergent reservoir and apply to the area being cleaned at low pressure. Allow the detergent remain on the surface for a few minutes, but do not let the detergent dry.

Rinse at high pressure using the fan spray keeping the tip of the spray nozzle at least 1-3 inches from the cleaning surface. Maintain a greater distance from the cleaning area when using a direct spray.

TECHNICAL DATA

Main voltage	120 V
Main frequency	60 Hz
Max. operating pressure	1800PSI
Water consumption	1.6 GPM
Max. pressure water supply	40-80PSI
Max. water temperature	40-140F(5-60°C)
Weight	20LBS

WARRANTY REGARDING

Refer to the enclosed guarantee conditions for the terms and conditions of guarantee.

ENVIRONMENT

Should your machine need replacement after extended use, please do not dispose with regular wash but dispose of it in an environmentally safe way.

1800 PSI Pressure Washer

TROUBLESHOOTING TIPS

WHEN THE SWITCH IS IN THE "I" POSITION THE MACHINE WILL NOT START

PROBABLE CAUSE

Electrical socket is faulty
Voltage is inadequate
GFCI trips
Power cord is not plugged in

SOLUTION

Check plug, socket, and fuses
Check that the voltage is adequate
Reset / Try another outlet
Plug in power cord

THE PUMP DOES NOT REACH ADEQUATE PRESSURE OR FLUCTUATES

PROBABLE CAUSE

Water Intake Filter is clogged
Pump is drawing air
Suction valves are clogged/worn
Diameter of garden hose too small
Water supply is restricted
Insufficient water supply

SOLUTION

Remove and clean filter
Tighten connections/bleed system
Clean or replace valves
Replace with to 1" inch garden hose
Check hose for kinks or leaks
Fully open the water source

THE PRESSURE WASHER HAS OR WILL NOT MAINTAIN PRESSURE

PROBABLE CAUSE

Excessive air in waterline and pump

SOLUTION

Turn unit and water supply off
and bleed lines

THE PRESSURE WASHER MAKES EXCESSIVE NOISE

PROBABLE CAUSE

Intake is blocked
Valves are worn, dirty, or clogged
Water Intake Filter is dirty

SOLUTION

Check the intake valves
Check, clean or replace valves
Check, clean, or replace filter

THE MOTOR STOPS RUNNING WHILE IN USE

PROBABLE CAUSE

Net voltage lower than suggested

SOLUTION

Check to determine the voltage is adequate

1800PSI PRESSURE WASHER

LIMITED WARRANTY

Pulsar Products, Inc. warrants to the original purchaser who uses the product in a consumer application (personal, residential or household usage) that all products covered under this warranty are free from defects in material and workmanship for one year from the date of purchase. All products covered by this limited warranty which are used in commercial applications (i.e. income producing) are warranted to be free of defects in material and workmanship for 90 days from the date of original purchase. Products covered under this warranty include air compressors, air tools, service parts, pressure washers and generators.

Pulsar Products, Inc. will repair or replace, at Pulsar Products, Inc.'s sole option, products or components which have failed within the warranty period. Service will be scheduled according to the normal work flow and business hours at the service center location, and the availability of replacement parts. All decisions of Pulsar Products, Inc. with regard to this limited warranty shall be final.

This warranty gives you specific legal rights, and you may also have other rights which vary from state to state.

RESPONSIBILITY OF ORIGINAL PURCHASER (initial User):

To process a warranty claim on this product, DO NOT return item to the retailer. The product must be evaluated by an Authorized Warranty Service Center. For the location of the nearest Authorized Warranty Service Center contact the retailer or place purchase.

Retain original cash your sales receipt as proof of purchase for all warranty work.

Use reasonable care in the operation and maintenance of the product as described in the Owner's Manual(s).

Deliver or ship the product to the Authorized Warranty Service Center. Freight costs, if any must be paid by the purchaser.

If the purchaser does not receive satisfactory results from the Authorized Warranty Service Center, the purchaser should contact Pulsar Products, Inc..

1800PSI PRESSURE WASHER

LIMITED WARRANTY (cont'd)

THIS WARRANTY DOES NOT COVER:

- Merchandise sold as reconditioned, used as rental equipment, or floor or display models.
- Merchandise that has become damaged or inoperative because of ordinary wear, misuse, cold, heat, rain, excessive humidity, freeze damage, use of improper chemicals, negligence, accident, failure to operate the product in accordance with the instructions provided in the Owner's Manual(s) supplied with the product, improper maintenance, the use of accessories or attachments not recommended by Pulsar Products, Inc., or unauthorized repair or alterations.
- Repair and transportation costs of merchandise determined not to be defective.
- Costs associated with assembly, required oil, adjustments or other installation and start up costs.
- Expendable parts or accessories supplied with the product which are expected to become inoperative or unusable after a reasonable period of use.
- Merchandise sold by Pulsar Products, Inc. which has been manufactured by and identified as the product of another company, such as gasoline engines. The product manufacturer's warranty, if any, will apply.
- ANY INCIDENTAL, INDIRECT OR CONSEQUENTIAL LOSS, DAMAGE, OR EXPENSE THAT MAY RESULT FROM ANY DEFECTS, FAILURE OR MALFUNCTION OF THE PRODUCT IS NOT COVERED BY THIS WARRANTY. Some states do not allow exclusion, so it may not apply to you.
- IMPLIED WARRANTIES, INCLUDING THOSE OF MERCHANTABILITY OR FITNESS FOR A PARTICULAR PURPOSE, ARE LIMITED TO ONE YEAR FROM THE DATE OF ORIGINAL PURCHASE. Some states do not allow limitations on how long an implied warranty lasts, so the above limitations may not apply to you.

1800PSI PRESSURE WASHER

EXPLODED VIEW

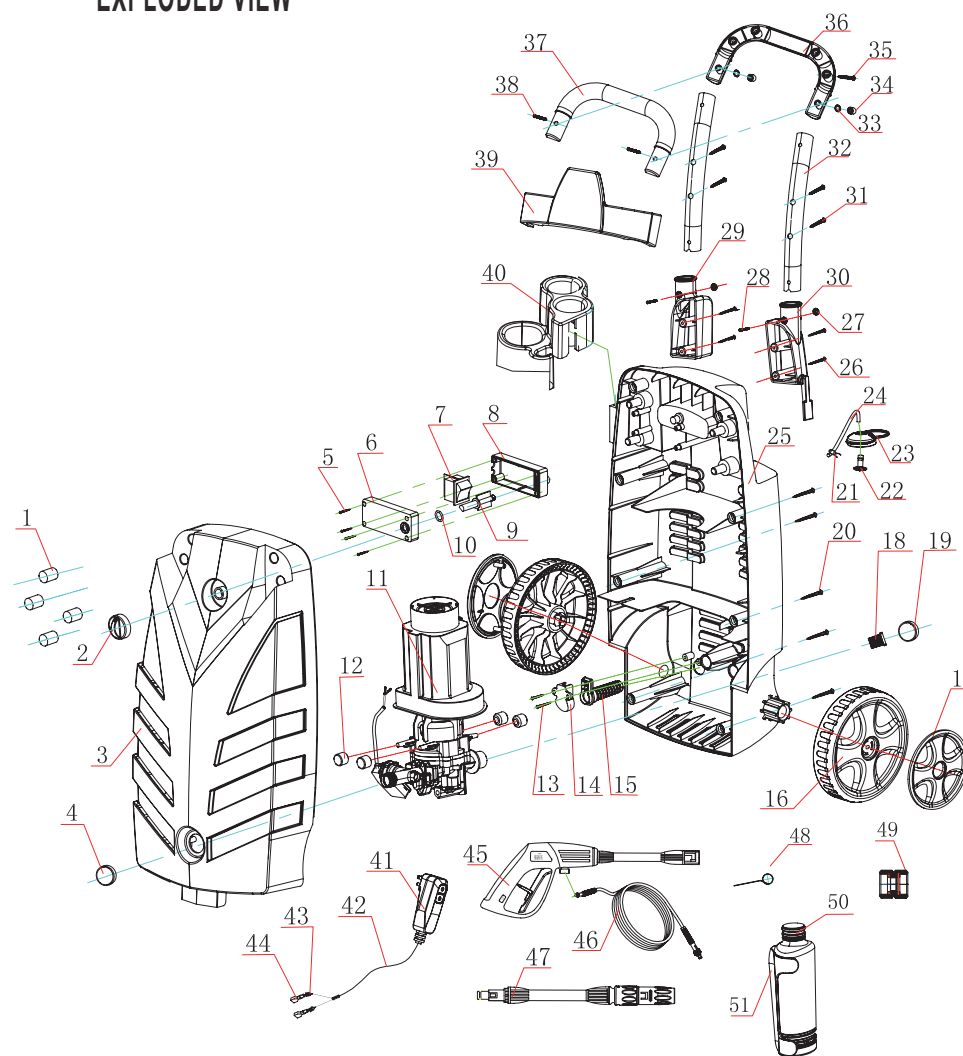

1800PSI PRESSURE WASHER

PARTS LISTING

Part No	Description	Part No.
PWE1800-01	Rubber Stopper	4
PWE1800-02	Switch Knob	1
PWE1800-03	Case(Front)	1
PWE1800-04	Outlet Cover	1
PWE1800-05	Screw	4
PWE1800-06	Switch Case(Front)	1
PWE1800-07	Switch	1
PWE1800-08	Switch Case(Rear)	1
PWE1800-09	Staff	1
PWE1800-10	O-Ring	9
PWE1800-11	Pump	2
PWE1800-12	Rubber Bands	4
PWE1800-13	Screw	2
PWE1800-14	Clip Cover	1
PWE1800-15	Jacket	1
PWE1800-16	Wheels	2
PWE1800-17	Wheel Caps	2
PWE1800-18	Filter	1
PWE1800-19	Inlet Cover	1
PWE1800-20	Screw	8
PWE1800-21	Detergent Tube Clip	1
PWE1800-22	Filter	1
PWE1800-23	Detergent Tank	1
PWE1800-24	Detergent Tube	1
PWE1800-25	Case(Rear)	1
PWE1800-26	Screw	4
PWE1800-27	Hex Nut	2
PWE1800-28	Bolt	2
PWE1800-29	Handle Fixture(Left)	1
PWE1800-30	Handle Fixture(Right)	1

1800PSI PRESSURE WASHER

PARTS LISTING

Part No	Description	Part No.
PWE1800-31	Screw	4
PWE1800-32	Aluminum	2
PWE1800-33	Spring Cushion	2
PWE1800-34	Hex Nut	2
PWE1800-35	Screw	4
PWE1800-36	Handle(Rear)	1
PWE1800-37	Handle(Front)	1
PWE1800-38	Bolt	2
PWE1800-39	Hook	1
PWE1800-40	Accessories Holder	1
PWE1800-41	GFCI	1
PWE1800-42	Power Cable	1
PWE1800-43	Straight Slot	2
PWE1800-44	Jacket	2
PWE1800-45	Gun Assembly	1
PWE1800-46	High Pressure Hose	1
PWE1800-47	Adjustable Lance	1
PWE1800-48	Cleaning Tip	1
PWE1800-49	Zinc Alloy Connector	1
PWE1800-50	Detergent Tank	1
PWE1800-51	Holder	1